

OUTENIQUA VEILING

GPS: -34.014971 S ; 22.275445 E

OUTENIQUA INTERRASVEILING

VRYDAG, 20 OKTOBER 2023

11H00 TE OUTENIQUA VEILINGSKOMPLEKS, GEORGE

VERSKEIE SKAAP- EN BEESRASSE SAL AANGEBIED WORD OP DIE VEILING
- DORMERS EN DORPERS WORD VERKOOP ONDER RASBESKERMING



BEESTE:

LIMOUSIN :

- 3 Dragtige Verse / Koeie SP
- 2 Oop Verse SP
- 2 Bulle SP

BONSMARA :

- 6 Bulle SP
- 24 verse kommersieel

SIMMENTALER :

- 10 Bulle SP
- 3 Dragtige Koeie Kommersieel
- 4 Koeie met Kalwers Kommersieel
- 34 Verse Kommersieel

SUSSEX :

- 2 Bulle SP

ROOI ANGUS :

- 3 Bulle SP
- 5 Vroulik Kommersieel

SWART ANGUS :

- 2 Koeie SP

JERSEY :

- 5 Verse Oop Kommersieel
- 5 Verse Dragtig Kommersieel

BRAHMAN :

- 15 Verse Kommersieel (by bul geloop)
- 5 Koeie met Kalwers Kommersieel

SKAPE:

DORMERS:

- 44 Ooie SP
- 28 Ramme SP
- 40 Ooie Kommersieel
- 8 Ramme Kudde

DORPERS :

- 3 Ramme SP

DAMARA :

- 10 Ooie Kommersieel
- 1 Kudde Ram

SUFFOLK :

- 5 Ramme SP

MEATMASTER :

- 8 Ramme Kudde

VELDMASTER :

- 12 Ooie Kommersieel

AANWYSINGS

Neem die N2 vanaf George in rigting van Mosselbaai en volg vir ± 15km, neem die Glentana afrit, draai regs en neem eerste grond- pad links (Jonkersberg) en volg BKB wegwysers



MEERKAT
ONLINE AUCTIONS

AFSLAERS:
RHEBOK STRAAT, INDUSTRIËLE AREA, HUMANSDORP
TEL. 087 920 4532 REG. NO. 08/12435/06

NAVRAE:

JAN ERASMUS (BESTUURDER HUMANSDORP)

BERRIE BOTHA (NAVRAE)

ORG VISSER (NAVRAE)

ANDRIE VISSER (BEMARKER)

FANUS MULLER (BEMARKER)

PIETER SCHUTTE

PIETER AUCAMP (TEGNESE ADVISEUR, SKAAP EN WOL)

AFSLAERS: RENIER ZIETSMAN (BEES)

LEN BORNMAN (SKAAP)

082 924 6096

082 440 2763

082 944 0697

083 270 5703

076 577 6744

082 496 5986

082 825 3890

082 491 5182

082 551 6839

BESOEK ONS BY WWW.BKB.CO.ZA

BKB
LEWENDEHAWE &
AFSLAERSDIENSTE

BKB



Welkom by die veiling.
Welcome to the auction.



It's more than just climate change, it's securing your business's future

Let's help your business get there
with FNB Sustainable Finance

[Switch to FNB Business](#)

Get the help you need

Terms and conditions apply.

First National Bank A division of FirstRand Bank Limited.
An Authorised Financial Services and Credit Provider (NCRCP20).





Belê in oplossings vir alternatiewe energie

Ons verstaan die uitdagings verbonde aan energiekoste en hoe die verskaffing daarvan besighede landwyd kan beïnvloed. By FNB bied ons finansiering van oplossings vir alternatiewe energie, wat besparings oor die lang termyn kan verskaf én sal help met ononderbroke besigheidsproduktiwiteit.

Praat met 'n verhoudingsbestuurder by jou naaste FNB-tak of stuur 'n e-pos na AlternativeEnergy@fnb.co.za vir meer inligting.

Sluit by **#TheChangeables** aan

Kry die hulp wat jy nodig het





RULES OF AUCTION - TERMS AND CONDITIONS

1. This auction will be held under the control of BKB Limited (Pty) Limited (hereinafter referred to as the Auctioneer) with business premises situated at: Rhebok Street, Industrial Area, Humansdorp, 6300
2. The Auctioneer is hereby appointed by the Purchaser and Seller to act for and on behalf of the Purchaser and Seller as agent in accordance with Section 54 of the Value-Added Tax Act, 1991, in respect of all tax invoices, credit and/or debit notes in respect of all livestock, game and/or goods offered at the auction or any costs of transport and insurances premiums paid for on behalf of the Purchaser and Seller.
3. The rules of this auction shall comply with the provisions of Section 45 and all relevant regulations to the Consumer Protection Act 68 of 2008.
4. For greater clarity Section 45(1-4) states as follows:
 - 4.1 In this section, "auction" includes a sale in execution of or pursuant to a court order, to the extent that the order contemplates that the sale is to be conducted by an auction. 4.2 When goods are put up for sale by auction, each lot is, unless there is evidence to the contrary, regarded to be the subject of a separate transaction.
 - 4.3 A sale by auction is complete when the auctioneer announces its completion by the fall of the hammer, or in any other customary manner, and until that announcement is made, a bid may be retracted. 4.4 Notice must be given in advance that a lot or sale by auction is subject to:
 - 4.4.1 A reserved or upset price; or
 - 4.4.2 A right to bid by or on behalf of the owner or auctioneer, in which case the owner or auctioneer, or any one person on behalf of the owner or auctioneer, as the case may be, may bid at the auction.
5. Until the fall of the hammer as contemplated in Section 45(3) of the Act, any bid may be retracted or declined by the Auctioneer if not compliant with the regulations of the Consumer Protection Act.
6. The auction is not an absolute auction but subject to reserved prices settled by the sellers and as pointed out by the Auctioneer prior to the sale of the set asset or lot.
7. The auction shall take place at the date and time as advertised or published and will not be postponed or delayed to enable any member or group of the public to partake in the auction.
8. Should the Auctioneer become aware of any fault on advertising material or any other publication or amendment to these Rules of Auction, the Auctioneer will prior to the auction point out and when necessary amend such mistakes in the advertisement or publication.
9. Any person attending the auction to enter a bid, must prior to the auction register as a buyer on the bidders' roll and comply with the conditions as set out in Chapter 1 of FICA 2001. The purchaser shall sign the bidders' roll card.
10. Any person who attends the auction to enter a bid on behalf of another person must be duly authorised thereto by means of a written letter of authority from its principal and such a person together with his principal must both register prior to the auction on the bidders' roll and provide all necessary information as required in Chapter 1 of the regulations issued in terms of FICA 2001 with regard to proof of its identity. The bidders' roll must be signed by such a person and on behalf of its principal.
11. Where the principal is a company the letters of authority shall appear on the letterhead of the company together with a certified copy of a resolution authorizing the person to bid on behalf of the company. (For purposes of this rule any reference to a company will include any reference to juristic person including partnerships, trusts or incorporated entities).
12. All purchasers have a right of inspection of all goods put up for sale and the auctioneer shall provide reasonable time and access prior to the start of the auction for such an inspection.
13. All livestock and goods are sold "voetstoots" and the purchasers do not enjoy the protection of Section 55 and 56 of the Consumer Protection Act.
14. Any information provided regarding the quality, breeding, age, date of insemination, condition, reproductive status or any information regarding health, production or mass or any other aspect of the livestock, is provided by the seller and any misrepresentation by the seller is without the cooperation or knowledge of the Auctioneer. Any right of recourse as a result of such misrepresentation shall be against the seller.
15. Any bid made does not include VAT which, where applicable, will be added to the bidding price for which a VAT invoice will be issued.
16. All sales are for cash and purchase price is payable immediately to the Auctioneer on acceptance of the bid unless otherwise arranged prior to the auction with the Auctioneer. Any payment made in cash is further subject to cash or any other handling fees. Should the Purchaser however fail to make payment within 7 days from date of delivery, BKB will be entitled to add interest calculated at the current bank prime rate plus 5% to the capital amount outstanding. The interest will be calculated monthly and capitalised.
17. Should the purchaser not pay the purchase price immediately and has failed to make arrangements for payment with the Auctioneer, then the Auctioneer can/will cancel the sale and treat the assets or lots as unsold lots which may again be presented on the auction for sale or be sold out of hand by means of liaison services, depending on the sellers mandate to the auctioneer.
18. Ownership in the lot or assets will remain that of the seller until the purchase price has been paid in full to the seller with the provision that the risk in the assets or lot passes to the purchaser at the fall of the hammer as set out in clause 24.
19. In the event that Purchaser has made necessary finance arrangements with BKB, the Purchaser hereby authorises BKB to pay the purchase price or costs of transport, insurance and any other agreed cost, minus BKB's commissions, on behalf of the Purchaser to the Seller and other service providers, in which event the said payment by BKB on behalf of the Purchaser will be deemed to be monies lent and advanced, the terms and conditions thereof being agreed with the Purchaser in a separate credit agreement or sale agreement. All payments made by BKB to the Seller on behalf of the Purchaser in terms of this clause will be made after the lapse of 5 (Five) working days from date of delivery of the asset to the Purchaser. Any payment made by BKB to the Seller prior to the lapse of the 5 (Five) working day period is made at the sole discretion of BKB and not an enforceable indulgence.
20. For as long as any amount is owing to BKB by the Purchaser, the Purchaser may not, where the assets are the subject of security of the Purchaser's credit facility with BKB, relinquish possession of the said asset, nor may he cease the asset or any of its rights and obligations in terms of this agreement to a third party or otherwise encumber, sell or dispose of the said asset or allow it to become the subject of any right of retention, hypothec, pledge or any encumbrance, whatever the cause thereof may be. BKB may be entitled to cease its rights and obligations without affecting its rights of recourse for any monies still due to it.
21. In the event of the Seller already being indebted to BKB or any of its affiliates at the time of this auction, the Seller hereby irrevocably authorises BKB to set off the purchase price due to the Seller by BKB (minus BKB's commission) against the amounts due by the Seller to BKB.
22. Where BKB, in terms of a credit agreement, lent and advanced monies to the Purchaser for payment of the purchase price of any asset or payment of any transport costs or insurance premiums, no defence of whatsoever nature which the Purchaser may raise against the Seller or the transport contractor or the insurance company may be raised against BKB and the Purchaser shall still be obligated to pay all amounts owing, together with further interest and costs thereon raised in terms of the credit agreement or sale agreement, to BKB. The conditions of this clause do not interfere with the rights, entitlements or remedies the Purchaser may have against the Seller, transport contractor or insurance company.
23. Neither the Purchaser, nor the Seller, shall be entitled to apply set-off or to retain any monies owing arising from any claim they may have against each other or BKB with regards to any amount owing in terms hereof. Each lot shall immediately after the fall of the hammer deemed to be delivered to the purchaser at which time the risk will pass to the purchaser who will at his own risk and cost remove the lots or assets from the auction terrain. Removal of any assets or lots however will not be allowed by the Auctioneer until payment of the purchase price by the purchaser or acceptable arrangements for payment thereof have been made by the purchaser with the Auctioneer.
24. Each lot shall immediately after the fall of the hammer deemed to be delivered to the purchaser at which time the risk will pass to the purchaser who will at his own risk and cost remove the lots or assets from the auction terrain. Removal of any assets or lots however will not be allowed by the Auctioneer until payment of the purchase price by the purchaser or acceptable arrangements for payment thereof have been made by the purchaser with the Auctioneer.
25. The Auctioneer will only be obliged to give reasons of the auction if such reasons are other than the voluntary sale of goods by its owners.
26. The bidders' roll and vendor roll will be available for inspection during the normal office hours at the business premises of the Auctioneer.
27. The rules of auction will only be read out at the auction if they were not available to the public at the place of business of the Auctioneer. In the event of livestock and game auctions, the rules of auction remain unchanged and are in general available at the business premises of the Auctioneer or on the website of the Auctioneer.
28. Under no circumstances will BKB be held liable for any loss or damage of any cause whatsoever albeit direct or indirect damages suffered by anyone if the livestock at the auction premises have to be placed under quarantine as a result of the presence of a livestock disease present. In such event BKB will have the right to cancel the auction as well as any already complete sales and no party will be entitled to have a right of recourse against BKB.
29. Any party requiring permits, removal certificates, documentation of identification or any other statutory prescribed document will solely be responsible for obtaining same. Any instructions to an auctioneer with regards to the loading, transporting, choice of transport contractors, insurance or choice of insurers will be executed at the sole risk of the person acquiring such services and the Auctioneer will not be held responsible for any losses whether direct or indirect which may be suffered as a result of giving effect to the instructions by the Auctioneer. The Auctioneer however does accept responsibility as contemplated in Section 35(2) of the Consumer Protection Act whilst the goods or lots are in the possession of the auctioneer. Any agreement entered into by the Auctioneer with a transport company or insurer is done so in its representative capacity of the seller or buyer. All transport costs or insurance premiums are therefore payable to the Auctioneer in cash except if acceptable alternative arrangements were made with the Auctioneer.
30. Both the seller and the buyer consent to the jurisdiction of the Magistrate's Court as contemplated in Section 46 of Act 32 of 1944 having regard to any action which the Auctioneer may institute against the buyer or seller irrespective of the cause of action. Notwithstanding the aforesaid the Auctioneer will have the sole and absolute discretion to institute action in any High Court with appropriate jurisdiction.
31. Any legal costs that BKB may have or will incur as a result of the non-compliance of the Purchaser and/or Seller in terms of its or their obligations herein, shall be recoverable by BKB, together with collection commissions from the Purchaser and/or Seller on a scale as between attorney and own client.
32. No variation, amendment, novation or addition to these terms and conditions will have the effect of BKB renouncing any of its rights in terms hereof, unless it is reduced to writing and signed by BKB.
33. No relaxation or indulgence by the Auctioneer must be interpreted as a waiver of any of the Auctioneer's rights in terms hereof. Such relaxation or indulgence must also not be interpreted as a novation hereof.
34. Should any condition be unlawful or become retrospectively unlawful, that unlawful condition shall be deemed to be amended to the extent and in the manner as is necessary to make it lawful or should such amendment be impossible, the unlawful conditions shall be deemed divisible from the remainder of the conditions and pro non scriptis.
35. The cattle scale despite being calibrated, is not verified in term of the Legal Metrology Act.
36. The weight as displayed for each lot is an unverified indication of average weight and may not be relied on for purposes of entering a bid.
37. All sales of livestock are sales per head of cattle and not per kilogram
38. Rules of auctions and term and conditions in other languages can be asked for.

BKB



Skaap / Sheep

OUTENIQUA INTERRASVEILING

20 OKTOBER 2023

LOT NR 1				
Verkoper	Beskrywing	Aantal	Koper	Prys
Westmar Dormers	Dormer Ram SP	1		

*W22.007

*REV 1, SLENKDAL, BLOUTONG A B C



OUTENIQUA INTERRASVEILING
Outeniqua Veilingkompleks, George 20 October 2023





WESTMAR DORMERS
Renuiburg, Free State
014 718277
n.Veent@gmail.com

W 220007
WM RAM W 220007

Hand Book	SP
Birth date	2022-05-17
Age	1.6 years
Woolshedding	6.86%
Birth Sex	2
Pregnancy	
None	

JNRDQ00223
JANOR RAM W 2200027

Percentage	Sire	Dam
DNA		
Genomic		

W 190045
WV EWE W 190045

W 190045
WV EWE W 190045

JS 140910
KINCO DOI JS 140910

NB 180525
NOVA BAKLEY RAM NB0525

JNRD70062
JANOR EWE W 2200062

W 170093
WESTLEY RAM W 170093

W 190045
WV EWE W 190045

JS 140910
KINCO DOI JS 140910

JOHANNI APOLLO
KINCO BAKLEY EWE NB0525

KAROS RAM JH 148095
KINCO BAKLEY EWE NB0525

JANOR EWE JNRD60028
KINCO BAKLEY EWE NB0525

JOHANNI RAM JB 165017
KINCO BAKLEY EWE NB0525

WESTLEY DOI W 160072
KINCO BAKLEY EWE NB0525

KINCO RAM JS 190033
KINCO BAKLEY EWE NB0525

KINCO EWE JS 120160
KINCO BAKLEY EWE NB0525

Growth			Reproduction			
Wt. Dtl.	Mean Nat.	Post. Aft.	NLW	TWW	AFL	LP
99	105	106	99	59	103	90
6%	4%	28%	30%	30%	23%	22%

LOGIX
EBV Analysis 2023-10-05

Logic Merit Index	104
Growth Index	105
Reproduction Index	105

SELLER REMARKS:

LOT NR 2				
Verkoper	Beskrywing	Aantal	Koper	Prys
Westmar Dormers	Dormer Ram SP	1		

*W22.014

*REV 1, SLENKDAL, BLOUTONG A B C



OUTENIQUA INTERRASVEILING
Outeniqua Veilingkompleks, George 20 October 2023





WESTMAR DORMERS
Renuiburg, Free State
014 718277
n.Veent@gmail.com

W 220014
WM RAM W 220014

Hand Book	SP
Birth date	2022-05-17
Age	1.6 years
Woolshedding	4.73%
Birth Sex	2
Pregnancy	
None	

W 190060
WM RAM W 190060

Percentage	Sire	Dam
DNA		
Genomic		

W 190080
WM EWE W 190080

W 180040
WESTLEY EWE W 180040

J 150254
LEE/WKOP RAM J 150254

W 150171
WESTLEY EWE W 150171

J 150056
LEE/WKOP RAM J 150056

W 180040
WESTLEY EWE W 180040

LEEUWKOP RAM J 150175
LEEUWKOP DOI J 150069

TOP 3 RAM AS 090367
WESTLEY DOI W 130076

JOHANNI RAM JB 100554
LEEUWKOP DOI J 150192

KINCO RAM JS 150719
KINCO DOI JS 140930

Growth			Reproduction			
Wt. Dtl.	Mean Nat.	Post. Aft.	NLW	TWW	AFL	LP
98	100	101	117	117	101	96
6%	4%	7%	33%	35%	31%	23%

LOGIX
EBV Analysis 2023-10-05

Logic Merit Index	110
Growth Index	102
Reproduction Index	117

SELLER REMARKS:

LOT NR 3				
Verkoper	Beskrywing	Aantal	Koper	Prys
Westmar Dormers	Dormer Ram SP	1		

*W22.038

*REV 1, SLENKDAL, BLOUTONG A B C



OUTENIQUA INTERRASVEILING
Outeniqua Veilingkompleks, George 20 October 2023





WESTMAR DORMERS
Renuiburg, Free State
014 718277
n.Veent@gmail.com

W 220038
WM RAM W 220038

Hand Book	SP
Birth date	2022-08-29
Age	1.1 years
Woolshedding	7.72%
Birth Sex	3
Pregnancy	
None	

W 190060
WM RAM W 190060

Percentage	Sire	Dam
DNA		
Genomic		

W 200001
WM EWE W 200001

J 220086
LEEUWKOP DOI J 220086

J 150254
LEE/WKOP RAM J 150254

W 150171
WESTLEY EWE W 150171

W 170093
WESTLEY RAM W 170093

J 220086
LEEUWKOP DOI J 220086

LEEUWKOP RAM J 150175
LEEUWKOP DOI J 150069

TOP 3 RAM AS 090367
WESTLEY DOI W 130076

JOHANNI RAM JB 140017
WESTLEY DOI W 150072

LEEUWKOP RAM J 190033
LEEUWKOP DOI J 070279

Growth			Reproduction			
Wt. Dtl.	Mean Nat.	Post. Aft.	NLW	TWW	AFL	LP
100	109	105	109	109	97	99
6%	4%	22%	34%	34%	30%	23%

LOGIX
EBV Analysis 2023-10-05

Logic Merit Index	115
Growth Index	113
Reproduction Index	117

SELLER REMARKS:

LOT NR 4				
Verkoper	Beskrywing	Aantal	Koper	Prys
Westmar Dormers	Dormer Ram SP	1		

*W22.020

*REV 1, SLENKDAL, BLOUTONG A B C

OUTENIQA INTERRASVEILING
Outeniqua Veilingskompleks, George 30 Oktober 2023



W 220020
WM RAM W 220020

Kaldebok SP
Geb. ddm 2022-03-17
Oud. 1,4 jaar
Inslag 4,69%
Geb. Status 2

Nagslag
Gen

W 190060
WM RAM W 190060

Ouerskap Year Moer
DNS
Genemissie

W 200015
WM FAE W 200015
Oud. 2,1 jaar
Genemissie

J 150254
LEEUWKOP RAM J 150254
Oud. 1,1 jaar
Genemissie

W 150071
WESTLEY EVE W 150071
Oud. 1,1 jaar
Genemissie

W 170093
WESTLEY RAM W 170093
Oud. 1,1 jaar
Genemissie

W 180041
WESTLEY EVE W 180041
Oud. 1,1 jaar
Genemissie

LEEUWKOP RAM J 150170
Oud. 1,1 jaar
Genemissie

LEEUWKOP OOI J 200059
Oud. 1,1 jaar
Genemissie

TOP 3 RAM ASJ090367
Oud. 1,1 jaar
Genemissie

WESTLEY OOI W 150076
Oud. 1,1 jaar
Genemissie

JOHANNI RAM JS 140007
Oud. 1,1 jaar
Genemissie

WESTLEY OOI W 150072
Oud. 1,1 jaar
Genemissie

KINKO RAM JS 150534
Oud. 1,1 jaar
Genemissie

KINKO OOI JS 140254
Oud. 1,1 jaar
Genemissie

Groei			Reproduksie			
Spm. Dn.	Spm. Mac.	Na. Spm.	GLS	TWW	OEL	LP
100	102	102	34%	34%	95	93
60%	46%	2%			3%	24%

Logix Meriete Indeks 107

Groei Indeks 104

Reproduksie Indeks 111

VERKOPER OPMERKINGS:

LOT NR 5				
Verkoper	Beskrywing	Aantal	Koper	Prys
Westmar Dormers	Dormer Ram SP	1		

*W22.214

*REV 1, SLENKDAL, BLOUTONG A B C

W 220214
WM RAM W 220214

Kaldebok SP
Geb. ddm 2022-06-13
Oud. 1,4 jaar
Inslag 5,69%
Geb. Status 2

Nagslag
Gen

DR 190048
CONKERTZ RAM DR 190048
Ouerskap Year Moer
DNS
Genemissie

JT 180049
KINKO OOI JT 180049
Oud. 1,1 jaar
Genemissie

JT 140901
REMKUL OOI JT 140901
Oud. 1,1 jaar
Genemissie

JB 160248
JOHANNI RAM JB 160248
Oud. 1,1 jaar
Genemissie

JOHANNI OOI JB 090011
Oud. 1,1 jaar
Genemissie

T 150237
ZEBROERS OOI T 150237
Oud. 1,1 jaar
Genemissie

ZEBROERS RAM T 100177
Oud. 1,1 jaar
Genemissie

ZEBROERS OOI T 110037
Oud. 1,1 jaar
Genemissie

DZ 160110
DROEVRIVER RAM DZ 160110
Oud. 1,1 jaar
Genemissie

JOHANNI RAM JB 100074
Oud. 1,1 jaar
Genemissie

DROEVRIVER OOI DZ 120140
Oud. 1,1 jaar
Genemissie

KINKO RAM JS 150534
Oud. 1,1 jaar
Genemissie

REMKUL OOI JT 140901
Oud. 1,1 jaar
Genemissie

REMKUL OOI JT 140901
Oud. 1,1 jaar
Genemissie

Groei			Reproduksie			
Spm. Dn.	Spm. Mac.	Na. Spm.	GLS	TWW	OEL	LP
111	109	114	93	93	96	88
38%	49%	3%			29%	26%

Logix Meriete Indeks 110

Groei Indeks 118

Reproduksie Indeks 103

VERKOPER OPMERKINGS:

LOT NR 6				
Verkoper	Beskrywing	Aantal	Koper	Prys
Welpic Dormers	Dormer Ram SP	1		

*JP 22:0082

JP 220082
WELPIC RAM JP 220082

Kaldebok SP
Geb. ddm 2022-04-10
Oud. 1,3 jaar
Inslag 4,69%
Geb. Status 1

Nagslag
Gen

JB 180008
JOHANNI RAM JB 180008
Ouerskap Year Moer
DNS
Genemissie

DE 180013
AAN DE VALLE RAM DE 180013
Oud. 1,1 jaar
Genemissie

DE 190220
AAN DE VALLE RAM DE 190220
Oud. 1,1 jaar
Genemissie

JT 160062
REMKUL RAM JT 160062
Oud. 1,1 jaar
Genemissie

REMKUL OOI JT 140888
Oud. 1,1 jaar
Genemissie

JB 170005
JOHANNI EVE JB 170005
Oud. 1,1 jaar
Genemissie

LEEUWKOP RAM JS0133
Oud. 1,1 jaar
Genemissie

JOHANNI OOI JB 120028
Oud. 1,1 jaar
Genemissie

DZ 140017
DROEVRIVER RAM DZ 140017
Oud. 1,1 jaar
Genemissie

DROEVRIVER OOI DZ 100097
Oud. 1,1 jaar
Genemissie

DROEVRIVER OOI DZ 070257
Oud. 1,1 jaar
Genemissie

AAN DE VALLE RAM DE 160035
Oud. 1,1 jaar
Genemissie

BB ADRI EVE OOI 070266
Oud. 1,1 jaar
Genemissie

Groei			Reproduksie			
Spm. Dn.	Spm. Mac.	Na. Spm.	GLS	TWW	OEL	LP
111	83	113	114	114	110	88
62%	53%	45%	39%	39%	38%	3%

Logix Meriete Indeks 113

Groei Indeks 106

Reproduksie Indeks 108

VERKOPER OPMERKINGS:

LOT NR 7				
Verkoper	Beskrywing	Aantal	Koper	Prys
Welpic Dormers	Dormer Ram SP	1		

*JP 22:0036



WELPIC DORMERS
Lady Grey Estate Cape
082349334
welpico@msn@gmail.com

JP 220036
WELPIC RAM JP220036

Herd Book: SP
Birth date: 2022-04-07
Age: 1.5 years
Inbreeding: 4.99%
Birth Sex: 1

Progeny: None

DZ 170116
DORMER RAM DZ 170116

DZ 140210
DORMER COI DZ 140210

JP 140021
WELPIC EWE JP140021

DZ 110115
DORMER RAM DZ 110115

DZ 140210
DORMER COI DZ 140210

JB 120113
JO-HAN RAM JB 120113

JP 120011
WELPIC COI JP 120011

DORMER RAM DZ 070913
DORMER COI DZ 080255

DORMER RAM DZ 110007
DORMER COI DZ 130114

JO-HAN RAM JB 110007
LSEUWOP COI JB 060102

WELPIC RAM JP 090111
WELPIC COI JP 050509

Growth			Reproduction			
Wt. Dr.	Wean Mac.	Post. Wt.	NLW	TYW	AFL	LP
101	66	93	112	112	112	106
43%	6%	46%	5%	5%	47%	38%

LOGIX
EBV Analysis 2023-10-05

Logic Merit Index **107**
Growth Index **97**
Reproduction Index **109**

SELLER REMARKS:

LOT NR 8				
Verkoper	Beskrywing	Aantal	Koper	Prys
Welpic Dormers	Dormer Ram SP	1		

*JP 22:0171



WELPIC DORMERS
Lady Grey Estate Cape
082349334
welpico@msn@gmail.com

JP 220171
WELPIC RAM JP220171

Herd Book: SP
Birth date: 2022-04-13
Age: 1.5 years
Inbreeding: 4.92%
Birth Sex: 2

Progeny: None

JB 180008
JO-HAN RAM JB 180008

JP 170047
WELPIC EWE JP170047

JB 170005
JO-HAN EWE JB 170005

JB 120113
JO-HAN RAM JB 120113

JP 120084
WELPIC COI JP 120084

JT 160062
REVELL RAM JT 160062

REVELL COI JT 140888
LSEUWOP RAM JB 050113

JO-HAN COI JB 120026
JO-HAN RAM JB 110007

LSEUWOP COI JB 060102
WANTHIS RAM VR 030040

WELPIC COI JP 100114

Growth			Reproduction			
Wt. Dr.	Wean Mac.	Post. Wt.	NLW	TYW	AFL	LP
111	90	114	131	131	105	102
43%	5%	4%	6%	4%	33%	37%

LOGIX
EBV Analysis 2023-10-05

Logic Merit Index **124**
Growth Index **109**
Reproduction Index **126**

SELLER REMARKS:

LOT NR 11				
Verkoper	Beskrywing	Aantal	Koper	Prys
Nuweland Dormers	Dormer Ram SP	1		

*NL 22-121

*INENTINGS / DOSSEERINGS : BLOUTONG, CLOSTRIVAX



NUWELAND DORMERS
Melroseburg Western Cape
en@nuweland.co.za

NL 220121
NUWELAND RAM NL 220121

Herd Book: SP
Birth date: 2022-03-31
Age: 1.6 years
Inbreeding: 5.23%
Birth Sex: 2

Progeny: None

NL 200085
NUWELAND RAM NL 200085

NL 170041
NUWELAND COI NL 170041

NL 140004
NUWELAND RAM NL 140004

NL 170023
NUWELAND COI NL 170023

NL 150375
NUWELAND COI NL 150375

ASJ 120433
TOP 3 RAM ASJ 120433

TOP 3 COI ASJ 100080
NUWELAND RAM NL 150050

NUWELAND COI NL 120259
NUWELAND RAM NL 110053

NUWELAND COI NL 120460
NUWELAND RAM NL 130155

NUWELAND EWE NL 110023

Growth			Reproduction			
Wt. Dr.	Wean Mac.	Post. Wt.	NLW	TYW	AFL	LP
91	114	99	94	94	108	97
40%	4%	50%	33%	35%	29%	26%

LOGIX
EBV Analysis 2023-10-05

Logic Merit Index **100**
Growth Index **102**
Reproduction Index **108**

SELLER REMARKS:

LOT NR 12				
Verkoper	Beskrywing	Aantal	Koper	Prys
Nuweland Dormers	Dormer Ram SP	1		

*NL 21-153

*INENTINGS / DOSSEERINGS : BLOUTONG, CLOSTRIVAX



NUWELAND DORMERS
Middelburg, Western Cape
ejen@nuweland.co.za

NL 210153
NUWELAND RAM NL 210153

Kuddeboek SP
Geb. dtn 2021-07-18
Oud. 2,8 jaar
Intelig. 5,73%
Gr. Status 1
Nageslag
Gen

Dienstep / Vtar. Noer
DNS
Geneties

NL 200010
NUWELAND DOI NL 200010
Geb. dtn 17-08-1996
Oud. 11,3 jaar
Intelig. 5,16%
Gr. Status 1

NL 160049
NUWELAND RAM NL 160049

NL 140118
NUWELAND DOI NL 140118
Geb. dtn 17-08-1994
Oud. 11,3 jaar
Intelig. 5,16%
Gr. Status 1

JT 180462
REKUL RAM JT 180462
Geb. dtn 17-08-1994
Oud. 11,3 jaar
Intelig. 5,16%
Gr. Status 1

NL 170163
NUWELAND DOI NL 170163
Geb. dtn 17-08-1994
Oud. 11,3 jaar
Intelig. 5,16%
Gr. Status 1

NUWELAND RAN NL 160019
Geb. dtn 17-08-1994
Oud. 11,3 jaar
Intelig. 5,16%
Gr. Status 1

NUWELAND DOI NL 192267
Geb. dtn 17-08-1994
Oud. 11,3 jaar
Intelig. 5,16%
Gr. Status 1

REKUL RAM AP 160048
Geb. dtn 17-08-1994
Oud. 11,3 jaar
Intelig. 5,16%
Gr. Status 1

NUWELAND DOI NL 090017
Geb. dtn 17-08-1994
Oud. 11,3 jaar
Intelig. 5,16%
Gr. Status 1

KONKO RAM JS 130258
Geb. dtn 17-08-1994
Oud. 11,3 jaar
Intelig. 5,16%
Gr. Status 1

REKUL DOI JT 130308
Geb. dtn 17-08-1994
Oud. 11,3 jaar
Intelig. 5,16%
Gr. Status 1

TOP 3 RAM ASJ 120435
Geb. dtn 17-08-1994
Oud. 11,3 jaar
Intelig. 5,16%
Gr. Status 1

NUWELAND DOI NL 140470
Geb. dtn 17-08-1994
Oud. 11,3 jaar
Intelig. 5,16%
Gr. Status 1

Groei			Reproduksie			
Spn. Dn.	Spn. Mac.	Ne-Spn.	GLS	TWW	CEL	LP
101	99	101	91	91	90	109
60%	60%	53%	33%	33%	30%	26%

LOGIX
EBV Analyse 2023-10-05

Logix Meriete Indeks **98**
Groei Indeks **104**
Reproduksie Indeks **93**

VERKOPER OPMERKINGS:

LOT NR 14				
Verkoper	Beskrywing	Aantal	Koper	Prys
Nuweland Dormers	Dormer Ram SP	1		

*NL 21-264

*INENTINGS / DOSSEERINGS : BLOUTONG, CLOSTRIVAX



NUWELAND DORMERS
Middelburg, Western Cape
ejen@nuweland.co.za

NL 210264
NUWELAND RAM NL210264

Kuddeboek SP
Geb. dtn 2021-11-06
Oud. 1,9 jaar
Intelig. 6,68%
Gr. Status 1
Nageslag
Gen

Dienstep / Vtar. Noer
DNS
Geneties

NL 200013
NUWELAND RAM NL 200013
Geb. dtn 17-08-1994
Oud. 11,3 jaar
Intelig. 5,16%
Gr. Status 1

AP 180192
PUNDT-180008 RAM AP 180192
Geb. dtn 17-08-1994
Oud. 11,3 jaar
Intelig. 5,16%
Gr. Status 1

NL 160006
NUWELAND DOI NL 160006
Geb. dtn 17-08-1994
Oud. 11,3 jaar
Intelig. 5,16%
Gr. Status 1

AP 160078
REKUL RAM AP 160078
Geb. dtn 17-08-1994
Oud. 11,3 jaar
Intelig. 5,16%
Gr. Status 1

NL 190181
NUWELAND DOI NL 190181
Geb. dtn 17-08-1994
Oud. 11,3 jaar
Intelig. 5,16%
Gr. Status 1

NL 190182
NUWELAND DOI NL 190182
Geb. dtn 17-08-1994
Oud. 11,3 jaar
Intelig. 5,16%
Gr. Status 1

TOP 3 RAM ASJ 130392
Geb. dtn 17-08-1994
Oud. 11,3 jaar
Intelig. 5,16%
Gr. Status 1

REKUL RAM JT 130308
Geb. dtn 17-08-1994
Oud. 11,3 jaar
Intelig. 5,16%
Gr. Status 1

NUWELAND DOI NL 140092
Geb. dtn 17-08-1994
Oud. 11,3 jaar
Intelig. 5,16%
Gr. Status 1

NUWELAND DOI NL 100338
Geb. dtn 17-08-1994
Oud. 11,3 jaar
Intelig. 5,16%
Gr. Status 1

REKUL RAM JT 130325
Geb. dtn 17-08-1994
Oud. 11,3 jaar
Intelig. 5,16%
Gr. Status 1

NUWELAND DOI NL 140020
Geb. dtn 17-08-1994
Oud. 11,3 jaar
Intelig. 5,16%
Gr. Status 1

NUWELAND DOI NL 140033
Geb. dtn 17-08-1994
Oud. 11,3 jaar
Intelig. 5,16%
Gr. Status 1

Groei			Reproduksie			
Spn. Dn.	Spn. Mac.	Ne-Spn.	GLS	TWW	CEL	LP
94	114	104	95	95	110	107
56%	42%	49%	31%	31%	28%	20%

LOGIX
EBV Analyse 2023-10-05

Logix Meriete Indeks **104**
Groei Indeks **104**
Reproduksie Indeks **111**

VERKOPER OPMERKINGS:

LOT NR 15				
Verkoper	Beskrywing	Aantal	Koper	Prys
Nuweland Dormers	Dormer Ram SP	1		

*NL 21-271

*INENTINGS / DOSSEERINGS : BLOUTONG, CLOSTRIVAX



NUWELAND DORMERS
Middelburg, Western Cape
ejen@nuweland.co.za

NL 210271
NUWELAND RAM NL210271

Hard Book SP
Btm date 2021-11-08
Age 1,9 years
Intelig. 6,26%
B-th-Stat 2
Progeny
None

Percentage / Sire / Dam
DNA
Genetic

NL 200013
NUWELAND RAM NL 200013
Geb. dtn 17-08-1994
Oud. 11,3 jaar
Intelig. 5,16%
Gr. Status 1

AP 180192
PUNDT-180008 RAM AP 180192
Geb. dtn 17-08-1994
Oud. 11,3 jaar
Intelig. 5,16%
Gr. Status 1

NL 160006
NUWELAND DOI NL 160006
Geb. dtn 17-08-1994
Oud. 11,3 jaar
Intelig. 5,16%
Gr. Status 1

NL 170386
NUWELAND RAM NL 170386
Geb. dtn 17-08-1994
Oud. 11,3 jaar
Intelig. 5,16%
Gr. Status 1

NL 190149
NUWELAND DOI NL 190149
Geb. dtn 17-08-1994
Oud. 11,3 jaar
Intelig. 5,16%
Gr. Status 1

NL 190241
NUWELAND DOI NL 190241
Geb. dtn 17-08-1994
Oud. 11,3 jaar
Intelig. 5,16%
Gr. Status 1

TOP 3 RAM ASJ 130392
Geb. dtn 17-08-1994
Oud. 11,3 jaar
Intelig. 5,16%
Gr. Status 1

REKUL RAM JT 130308
Geb. dtn 17-08-1994
Oud. 11,3 jaar
Intelig. 5,16%
Gr. Status 1

NUWELAND DOI NL 140092
Geb. dtn 17-08-1994
Oud. 11,3 jaar
Intelig. 5,16%
Gr. Status 1

NUWELAND DOI NL 140020
Geb. dtn 17-08-1994
Oud. 11,3 jaar
Intelig. 5,16%
Gr. Status 1

NUWELAND DOI NL 140033
Geb. dtn 17-08-1994
Oud. 11,3 jaar
Intelig. 5,16%
Gr. Status 1

Growth			Reproduction			
Wt. Dn.	Wean Mac.	Post-Wt.	NDV	TWW	ARL	LP
89	102	97	112	112	105	101
50%	46%	51%	33%	33%	27%	21%

LOGIX
EBV Analyse 2023-10-05

Logix Merite Index **102**
Growth Index **94**
Reproduction Index **113**

SELLER REMARKS:

LOT NR 16				
Verkoper	Beskrywing	Aantal	Koper	Prys
Nuweland Dormers	Dormer Ram SP	1		

*NL 22-071

*INENTINGS / DOSSEERINGS : BLOUTONG, CLOSTRIVAX



NUWELAND DORMERS
Malmesbury, Western Cape
en@nuweland.co.za

NL 220071
NUWELAND RAM NL 220071

Herd Book	SP
Birth date	2022-03-16
Age	1.6 years
Inbreeding	6.48%
Birth Stat.	1
Progeny	None

Parentage	Side	Dam
DNA		
Genomic		

NL 200001
NUWELAND OOI NL 200001
AP 160042

NL 150319
NUWELAND OOI NL 150319
AP 180192

NL 200069
NUWELAND OOI NL 200069
NL 160143

Growth			Reproduction			
Wt. Dr.	Mean Hgt.	Post. Wt.	NEW	TWV	APL	LP
103	114	102	79	79	104	99
56%	43%	52%	3%	3%	29%	2%

LOGIX
EBV Analysis 2023-10-05

Logic Merit Index	101
Growth Index	112
Reproduction Index	96

SELLER REMARKS:

LOT NR 19				
Verkoper	Beskrywing	Aantal	Koper	Prys
Ducron	Dormer Ram SP	1		

*AJC 22-0001



DUCRON FARMS
George, Western Cape
jacob@ducronfarms.co.za

AJC 220001
DUCRON RAM AJC220001

Herd Book	SP
Birth date	2022-03-15
Age	1.6 years
Inbreeding	4.56%
Birth Stat.	2
Progeny	None

Parentage	Side	Dam
DNA		
Genomic		

JT 180648
REKUL RAM JT 180648

JT 160315
REKUL OOI JT 160315

K 130137
JABUWY RAM K 130137

JT 170661
REKUL OOI JT 170661

JT 160014
REKUL OOI JT 160014

Growth			Reproduction			
Wt. Dr.	Mean Hgt.	Post. Wt.	NEW	TWV	APL	LP
91	108	91	97	97	103	90
56%	49%	53%	36%	36%	33%	2%

LOGIX
EBV Analysis 2023-10-05

Logic Merit Index	97
Growth Index	99
Reproduction Index	103

SELLER REMARKS:

LOT NR 20				
Verkoper	Beskrywing	Aantal	Koper	Prys
Ducron	Dormer Ram SP	1		

*AJC 22-0006



DUCRON FARMS
George, Western Cape
jacob@ducronfarms.co.za

AJC 220006
DUCRON RAM AJC 220006

Herd Book	SP
Birth date	2022-05-13
Age	1.4 year
Inbreeding	5.7%
Birth Stat.	1
Progeny	None

Parentage	Side	Dam
DNA		
Genomic		

JT 190720
REKUL RAM JT 190720

JT 160212
REKUL OOI JT 160212

JT 160559
REKUL RAM JT 160559

JS 150223
KIND RAM JS 150223

Growth			Reproduksie			
Spn. Dr.	Spn. Hgt.	Na. Spn.	GLS	TWV	CEL	LP
102	111	105	97	97	97	101
54%	47%	50%	3%	3%	27%	2%

LOGIX
EBV Analysis 2023-10-05

Logic Merite Indeks	106
Groot Indeks	110
Reproduksie Indeks	106

VERKOPER OPPERKINGS:

LOT NR 21				
Verkoper	Beskrywing	Aantal	Koper	Prys
Ducron	Dormer Ram SP	1		

*AJC 22-0050



DUCRON FARMS
George, Western Cape
jacques@gethokings.co.za

AJC 220050
DUCRON RAM AJC 220050

Kuddeboek: SP
Geb. dttm: 2022-07-30
Oud: 1,3 jaar
Intel %: 5,62%
Geb. Status: 1

Quarantain / Year Noor
DNS
Geneties

AP 170081
REKUL RAM OOI AP 170081
Tel. 121 (1) 221 (1) 18
Lemb. 4 (1) Lemb. 2 (1) Lemb. 4

DZ 170232
DUCRON RAM OOI DZ 170232

JT 160704
REKUL OOI JT 160704
Tel. 121 (1) 221 (1) 18
Lemb. 7 (1) Lemb. 4 (1) Lemb. 7

JT 140756
REKUL RAM JT 140756

AP 150063
REKUL RAM OOI AP 150063
Tel. 121 (1) 221 (1) 18
Lemb. 3 (1) Lemb. 4 (1) Lemb. 4

DROEVER RAM DZ 14009
DROEVER OOI DZ 14009
Tel. 121 (1) 221 (1) 18
Lemb. 4 (1) Lemb. 7 (1) Lemb. 7

JABUWY RAM K 130137
REKUL OOI JT 100359
Tel. 121 (1) 221 (1) 18
Lemb. 7 (1) Lemb. 3 (1) Lemb. 4

DORWALD RAM OGS 100433
REKUL OOI JT 100310
Tel. 121 (1) 221 (1) 18
Lemb. 5 (1) Lemb. 2 (1) Lemb. 4

DROEVER RAM DZ 13052
REKUL OOI JT 100276
Tel. 121 (1) 221 (1) 18
Lemb. 4 (1) Lemb. 8 (1) Lemb. 8

Groeï			Reproduksie			
Spn. Dn.	Spn. Mac.	Na-Spn.	G.S.	TWW	CEL	ILP
106	106	110	93	93	106	99
50%	42%	49%	33%	33%	26%	22%

Logix Meriete Indeks 108
Groeï Indeks 112
Reproduksie Indeks 104

VERKOPER OPMERKINGS:

LOT NR 22				
Verkoper	Beskrywing	Aantal	Koper	Prys
Ducron	Dormer Ram SP	1		

*AJC 22-0017



DUCRON FARMS
George, Western Cape
jacques@gethokings.co.za

AJC 220017
DUCRON RAM AJC 220017

Kuddeboek: SP
Geb. dttm: 2022-05-27
Oud: 1,4 jaar
Intel %: 5,18%
Geb. Status: 3

Quarantain / Year Noor
DNS
Geneties

AJC 190007
DUCRON OOI AJC 190007
Tel. 121 (1) 221 (1) 18
Lemb. 3 (1) Lemb. 7 (1) Lemb. 7

AP 170392
REKUL RAM AP 170392

JT 160212
REKUL OOI JT 160212
Tel. 121 (1) 221 (1) 18
Lemb. 3 (1) Lemb. 3 (1) Lemb. 3

JS 170062
KIND RAM JS 170062

JS 150270
KIND OOI JS 150270
Tel. 121 (1) 221 (1) 18
Lemb. 8 (1) Lemb. 5 (1) Lemb. 8

REKUL RAM AP 150094
REKUL OOI AP 150094
Tel. 121 (1) 221 (1) 18
Lemb. 4 (1) Lemb. 7 (1) Lemb. 4

REKUL RAM JT 130357
REKUL OOI JT 100300
Tel. 121 (1) 221 (1) 18
Lemb. 4 (1) Lemb. 8 (1) Lemb. 7

KIND RAM JS 140752
KIND OOI JS 140378
Tel. 121 (1) 221 (1) 18
Lemb. 4 (1) Lemb. 4 (1) Lemb. 4

DROEVER RAM DZ 11045
KIND OOI JS 120605
Tel. 121 (1) 221 (1) 18
Lemb. 4 (1) Lemb. 3 (1) Lemb. 4

Groeï			Reproduksie			
Spn. Dn.	Spn. Mac.	Na-Spn.	G.S.	TWW	CEL	ILP
105	89	108	118	118	100	88
49%	43%	48%	31%	31%	21%	22%

Logix Meriete Indeks 111
Groeï Indeks 103
Reproduksie Indeks 112

VERKOPER OPMERKINGS:

LOT NR 23				
Verkoper	Beskrywing	Aantal	Koper	Prys
Ducron	Dormer Ram SP	1		

*AJC 22-0007



DUCRON FARMS
George, Western Cape
jacques@gethokings.co.za

AJC 220007
DUCRON RAM AJC 220007

Nerd Book: SP
B th date: 2022-05-14
Age: 1,4 years
Intel %: 8,29%
B th Syst: 2

Parentage Size Dam
DNA
Geneties

AJC 200003
DUCRON OOI AJC 200003
Tel. 121 (1) 221 (1) 18
Lemb. 7 (1) Lemb. 4 (1) Lemb. 4

AP 170392
REKUL RAM AP 170392

JT 160212
REKUL OOI JT 160212
Tel. 121 (1) 221 (1) 18
Lemb. 3 (1) Lemb. 3 (1) Lemb. 3

JT 170275
REKUL RAM JT 170275

JT 170508
REKUL OOI JT 170508
Tel. 121 (1) 221 (1) 18
Lemb. 7 (1) Lemb. 5 (1) Lemb. 8

REKUL RAM AP 150094
REKUL OOI AP 150094
Tel. 121 (1) 221 (1) 18
Lemb. 4 (1) Lemb. 7 (1) Lemb. 4

REKUL RAM JT 130357
REKUL OOI JT 100300
Tel. 121 (1) 221 (1) 18
Lemb. 4 (1) Lemb. 8 (1) Lemb. 7

JABUWY RAM K 130137
REKUL OOI JT 130639
Tel. 121 (1) 221 (1) 18
Lemb. 4 (1) Lemb. 3 (1) Lemb. 4

REKUL RAM JT 10084
REKUL OOI JT 120605
Tel. 121 (1) 221 (1) 18
Lemb. 4 (1) Lemb. 3 (1) Lemb. 4

Growth			Reproduction			
Spn. Dn.	Spn. Mac.	Part. Wn.	NDW	TWW	ARL	ILP
96	108	100	96	96	100	96
50%	42%	50%	32%	32%	29%	24%

Logix Merit Index 101
Growth Index 103
Reproduction Index 104

SELLER REMARKS:

LOT NR 24				
Verkoper	Beskrywing	Aantal	Koper	Prys
Ducron	Dormer Ram SP	1		

*AJC 21-0041



DUCRON FARMS
George, Western Cape
jucapen@gebfarms.co.za

AJC 210041
DUCRON RAM AJC 210041

Parentage: SP
Birth date: 2021-09-21
Age: 2.1 years
Inbreeding: 5.96%
Birth Sex: 1

Progeny:
None

CPG 160485
DORVALD RAM CPG 160485
AF: 12 | LP: 40 | BF: 10
Lambing 2 | Lambing 2 | Favour 2

JT 130448
REKUL OOJ JT 130448
AF: 18 | LP: 17 | BF: 10
Lambing 2 | Lambing 2 | Favour 2

JT 170275
REKUL RAM JT 170275
AF: 18 | LP: 17 | BF: 10
Lambing 2 | Lambing 2 | Favour 2

JT 170508
REKUL OOJ JT 170508
AF: 18 | LP: 17 | BF: 10
Lambing 2 | Lambing 2 | Favour 2

KINKO RAM JS 140018
DORVALD OOJ CPG 160485
AF: 12 | LP: 40 | BF: 10
Lambing 2 | Lambing 2 | Favour 2

REKUL OOJ JT 080206
AF: 18 | LP: 17 | BF: 10
Lambing 2 | Lambing 2 | Favour 2

JABUWY RAM K 130037
REKUL OOJ JT 130539
AF: 17 | LP: 16 | BF: 10
Lambing 2 | Lambing 2 | Favour 2

REKUL RAM JT 100064
REKUL OOJ JT 120065
AF: 18 | LP: 17 | BF: 10
Lambing 2 | Lambing 2 | Favour 2

Growth			Reproduction			
Wt. Dr.	Wean. Hgt.	Pct. Wt.	NDW	TWY	APL	LP
93	108	95	85	85	99	107
52%	44%	45%	19%	35%	32%	27%

LOGIX
EBV Analysis 2023-10-05

Logic Merit Index **93**
Growth Index **100**
Reproduction Index **94**

SELLER REMARKS:

LOT NR 24A				
Verkoper	Beskrywing	Aantal	Koper	Prys
Ducron	Dormer Ram SP	1		

*AJC 21-0047



DUCRON FARMS
George, Western Cape
jucapen@gebfarms.co.za

AJC 210047
DUCRON RAM AJC 210047

Parentage: SP
Birth date: 2021-09-25
Age: 2.1 years
Inbreeding: 4.69%
Birth Sex: 2

Progeny:
None

AJC 200015
DUCRON RAM AJC 200015

Parentage: SP
Birth date: 2021-09-25
Age: 2.1 years
Inbreeding: 4.69%
Birth Sex: 2

AJC 190028
DUCRON OOJ AJC 190028
AF: 20 | LP: 26 | BF: 11
Lambing 2 | Lambing 2 | Favour 2

JS 150535
DINO RAM JS 150535
AF: 12 | LP: 40 | BF: 10
Lambing 2 | Lambing 2 | Favour 2

JS 160315
DINO OOJ JS 160315
AF: 12 | LP: 40 | BF: 10
Lambing 2 | Lambing 2 | Favour 2

DZ 170232
DROEYVER RAM DZ 170232
AF: 18 | LP: 17 | BF: 10
Lambing 2 | Lambing 2 | Favour 2

JT 140610
REKUL OOJ JT 140610
AF: 18 | LP: 17 | BF: 10
Lambing 2 | Lambing 2 | Favour 2

KINKO RAM JS 140007
KINKO OOJ JS 120051
AF: 18 | LP: 17 | BF: 10
Lambing 2 | Lambing 2 | Favour 2

KINKO RAM JS 150045
KINKO OOJ JS 140074
AF: 12 | LP: 40 | BF: 10
Lambing 2 | Lambing 2 | Favour 2

DROEYVER RAM DZ 140017
DROEYVER OOJ DZ 150014
AF: 18 | LP: 17 | BF: 10
Lambing 2 | Lambing 2 | Favour 2

REKUL RAM JT 120017
REKUL OOJ JT 130001
AF: 18 | LP: 17 | BF: 10
Lambing 2 | Lambing 2 | Favour 2

Growth			Reproduction			
Wt. Dr.	Wean. Hgt.	Pct. Wt.	NDW	TWY	APL	LP
104	87	105	98	98	105	99
52%	42%	38%	3%	3%	26%	2%

LOGIX
EBV Analysis 2023-10-05

Logic Merit Index **101**
Growth Index **101**
Reproduction Index **96**

SELLER REMARKS:

LOT NR 25				
Verkoper	Beskrywing	Aantal	Koper	Prys
Ruswater Dormers	Dormer Ram SP	1		

*#32



F.J. KRUGER
Ruswater Dormers, North West
082859867
ruswaterkruger@gmail.com

RW 220032
RUSWATER RAM RW 220032

Parentage: SP
Birth date: 2022-05-02
Age: 1.5 years
Inbreeding: 4.23%
Birth Sex: 2

Progeny:
None

NB 190462
NONA BARILETTA RAM NB 190462
AF: 12 | LP: 40 | BF: 10
Lambing 2 | Lambing 2 | Favour 2

NB 160035
NONA BARILETTA OOJ NB 160035
AF: 20 | LP: 26 | BF: 11
Lambing 2 | Lambing 2 | Favour 2

JB 130156
JOHANN RAM JB 130156
AF: 18 | LP: 17 | BF: 10
Lambing 2 | Lambing 2 | Favour 2

AP 130191
APENOS DROEYVER OOJ AP 130191
AF: 18 | LP: 17 | BF: 10
Lambing 2 | Lambing 2 | Favour 2

ZEBERS RAM T 10077
ZEBERS OOJ T 120148
AF: 20 | LP: 26 | BF: 11
Lambing 2 | Lambing 2 | Favour 2

NONA BARILETTA RAM NB 0019
NONA BARILETTA OOJ NB 10045
AF: 20 | LP: 26 | BF: 11
Lambing 2 | Lambing 2 | Favour 2

JOHANN RAM JB 13017
JOHANN OOJ JB 130090
AF: 18 | LP: 17 | BF: 10
Lambing 2 | Lambing 2 | Favour 2

REKUL OOJ JT 130001
AF: 18 | LP: 17 | BF: 10
Lambing 2 | Lambing 2 | Favour 2

Growth			Reproduction			
Wt. Dr.	Wean. Hgt.	Pct. Wt.	NDW	TWY	APL	LP
87	104	83	97	97	111	93
63%	54%	53%	42%	42%	34%	30%

LOGIX
EBV Analysis 2023-10-05

Logic Merit Index **95**
Growth Index **93**
Reproduction Index **103**

SELLER REMARKS:

LOT NR 26				
Verkoper	Beskrywing	Aantal	Koper	Prys
Ruswater Dormers	Dormer Ram SP	1		

*#36



F.J. KRUGER
Rooibosdam, North West
082859867
ruswaterkruger@gmail.com

RW 220036
RUSWATER RAM RW 220036

Kinderskap	SP
Geb. dnr	2022-05-02
Oud.	1,5 jaar
Inleëding	8,04%
Geb. Siste	2
Magelag	
Geby	

JB 190017
JOHANNI RAM JB190017

Duurskap / Veer Noer
DNS
Geneties

RW 200183
RUSWATER EWE RW200183
08.10.19.2019.19.20
Lanka 2 / Lanka 4 / Lankas 4

JP 170020
WELPOORAN JP170020

W 140211
WESTLEY DOU W 140211
08.10.19.2019.19.20
Lanka 4 / Lanka 0 / Lankas 0

T 180004
ZEBERS RAM T180004

RW 160039
RUSWATER EWE RW160039
08.10.19.2019.19.20
Lanka 0 / Lanka 0 / Lankas 0

JOHANNI RAM JB 110034
WELPIC EWE JP180074
08.10.19.2019.19.20
Lanka 5 / Lanka 0 / Lankas 0

TOP 3 RAM ASJ990367
WESTLEY DOU W 100235
08.10.19.2019.19.20
Lanka 0 / Lanka 0 / Lankas 1

LEEUWKOP RAM J 140023
ZEBERS DOU T 140046
08.10.19.2019.19.20
Lanka 0 / Lanka 0 / Lankas 0

REKOSTERBOERIE RAM AP 180020
BB AGRI EWE QJ10044
08.10.19.2019.19.20
Lanka 0 / Lanka 0 / Lankas 0

Groe			Reproduksie			
Spn. Dn.	Spn. Hec.	Na. Spn.	G.S	TWW	ARL	LP
91	111	97	110	110	96	122
38%	43%	50%	34%	34%	31%	25%

LOGIX
EBV Analysis 2023-10-05

VERKOPER OPMERKINGS:

Logix Meriete Indeks	107
Groe Indeks	100
Reproduksie Indeks	117

LOT NR 27				
Verkoper	Beskrywing	Aantal	Koper	Prys
Ruswater Dormers	Dormer Ram SP	1		

*#84



F.J. KRUGER
Rooibosdam, North West
082859867
ruswaterkruger@gmail.com

RW 220084
RUSWATER RAM RW 220084

Kinderskap	SP
Birth date	2022-05-05
Age	1,5 years
Inleëding	7,94%
Birth Stat.	1
Progeny	
Naam	

JB 190017
JOHANNI RAM JB190017

Percentage / Sire / Dam
DNA
Geneties

RW 200156
RUSWATER DOU RW200156
08.10.19.2019.19.20
Lanka 1 / Lanka 1 / Lankas 1

JP 170020
WELPOORAN JP170020

W 140211
WESTLEY DOU W 140211
08.10.19.2019.19.20
Lanka 0 / Lanka 0 / Lankas 0

T 180004
ZEBERS RAM T180004

RW 130008
RUSWATER DOU RW 130008
08.10.19.2019.19.20
Lanka 0 / Lanka 0 / Lankas 0

JOHANNI RAM JB 110034
WELPIC EWE JP180074
08.10.19.2019.19.20
Lanka 5 / Lanka 0 / Lankas 0

TOP 3 RAM ASJ990367
WESTLEY DOU W 100235
08.10.19.2019.19.20
Lanka 0 / Lanka 0 / Lankas 0

LEEUWKOP RAM J 140023
ZEBERS DOU T 140046
08.10.19.2019.19.20
Lanka 0 / Lanka 0 / Lankas 0

AAN DE VALLE RAM DE180019
RUSWATER DOU RW 130002
08.10.19.2019.19.20
Lanka 2 / Lanka 0 / Lankas 2

Growth			Reproduction			
Wn. Dn.	Wn. Hec.	Post. Wn.	NEW	TWW	ARL	LP
91	111	96	99	99	94	119
38%	43%	50%	34%	34%	31%	25%

LOGIX
EBV Analysis 2023-10-05

SELLER REMARKS:

Logix Merit Index	100
Growth Index	100
Reproduction Index	107

LOT NR 31				
Verkoper	Beskrywing	Aantal	Koper	Prys
Skaapvlei Dormers	Dormer Ram SP	1		

*JN 22.85

*INENTINGS / DOSSEERINGS : BLOUTONG A B C, MULTI



J.J. NEL & SEUN
Layby Grey, Eastern Cape
v.c@nelandseun.co.za

JN 220085
SKAAPVLEI RAM JN 220085

Kinderskap	SP
Birth date	2022-08-25
Age	1,1 years
Inleëding	8,42%
Birth Stat.	1
Progeny	
Naam	

JN 200007
SKAAPVLEI RAM JN 200007

Percentage / Sire / Dam
DNA
Geneties

JN 190036
SKAAPVLEI EWE JN190036
08.10.19.2019.19.20
Lanka 2 / Lanka 0 / Lankas 2

DE 190043
AAN DE VALLE RAM DE 190043

JN 180001
SKAAPVLEI EWE JN180001
08.10.19.2019.19.20
Lanka 0 / Lanka 0 / Lankas 0

T 180036
ZEBERS RAM T180036

JN 150024
SKAAPVLEI EWE JN150024
08.10.19.2019.19.20
Lanka 4 / Lanka 0 / Lankas 0

AAN DE VALLE RAM DE 180012
AAN DE VALLE DOU DE 150012
08.10.19.2019.19.20
Lanka 0 / Lanka 0 / Lankas 0

SKAAPVLEI RAM JN 180022
SKAAPVLEI DOU JN 180008
08.10.19.2019.19.20
Lanka 0 / Lanka 0 / Lankas 0

LEEUWKOP RAM J 140023
ZEBERS DOU T 150324
08.10.19.2019.19.20
Lanka 0 / Lanka 0 / Lankas 0

SKAAPVLEI RAM JN180021
SKAAPVLEI EWE JN180017
08.10.19.2019.19.20
Lanka 0 / Lanka 0 / Lankas 0

Growth			Reproduction			
Wn. Dn.	Wn. Hec.	Post. Wn.	NEW	TWW	ARL	LP
96	94	94	81	81	105	111
38%	43%	50%	30%	30%	38%	24%

LOGIX
EBV Analysis 2023-10-05

SELLER REMARKS:

Logix Merit Index	90
Growth Index	96
Reproduction Index	85

LOT NR 32				
Verkoper	Beskrywing	Aantal	Koper	Prys
Skaapvlei Dormers	Dormer Ram SP	1		

*JN 22.74

*INENTINGS / DOSSEERINGS : BLOUTONG A B C, MULTI



JJ. NEL & SEUN
Lady Grey Eastern Cape
vick@nj@peard.co.za

JN 220074
SKAAPVLEI RAM JN 220074

J. Hand Boek:	SP
Birth date:	2022-08-22
Age:	1.2 years
Inbreeding:	8.42%
Birth Stat:	1
Progeny:	None

Parentage	Size	Dim
DNA		
Genomic		

JN 200007
SKAAPVLEI RAM JN 200007

JN 180001
SKAAPVLEI EWE N180001

T 180036
28RIGERS RAM T180036

JN 190011
SKAAPVLEI EWE N190011

JN 170023
SKAAPVLEI OOI JN 170023

Growth			Reproduction			
Wt. Dr.	Wool Mat.	Post. Wt.	NEW	T/W	APL	LP
89	98	89	81	81	105	111
38%	43%	10%	29%	29%	28%	2%

LOGIX
EBV Analyse 2023-10-05

SELLER REMARKS:

Logix Merit Index	87
Growth Index	92
Reproduction Index	87

LOT NR 33				
Verkoper	Beskrywing	Aantal	Koper	Prys
Skaapvlei Dormers	Dormer Ram SP	1		

*JN 22.70

*INENTINGS / DOSSEERINGS : BLOUTONG A B C, MULTI



JJ. NEL & SEUN
Lady Grey Eastern Cape
vick@nj@peard.co.za

JN 220070
SKAAPVLEI RAM JN 220070

J. Kladderboek:	SP
Geb. dtn:	2022-08-21
Oor:	1.2 jaar
Inbreng:	20.17%
Geb. Stat:	2
Nageslag:	
Soort:	

Querskap	Waar	Noer
DNS		
Geneties		

JN 200007
SKAAPVLEI RAM JN 200007

JN 180001
SKAAPVLEI EWE N180001

DE 190043
AAN DE VALLEI RAM DE 190043

JN 200016
SKAAPVLEI OOI JN 200016

JN 150026
SKAAPVLEI OOI JN 150026

Growth			Reproduksie			
Spn. Dr.	Spn. Mat.	Na-Spn.	GLS	T/W	DEL	LP
96	97	98	86	86	110	109
39%	4%	23%	28%	28%	28%	0%

LOGIX
EBV Analyse 2023-10-05

VERKOPER OPMERKINGS:

Logix Merit Index	97
Growth Index	98
Reproduksie Index	96

LOT NR 34				
Verkoper	Beskrywing	Aantal	Koper	Prys
Skaapvlei Dormers	Dormer Ram SP	1		

*JN 22.27

*INENTINGS / DOSSEERINGS : BLOUTONG A B C, MULTI



JJ. NEL & SEUN
Lady Grey Eastern Cape
vick@nj@peard.co.za

JN 220027
SKAAPVLEI RAM JN 220027

J. Kladderboek:	SP
Geb. dtn:	2022-08-06
Leid:	1.2 jaar
Inbreng:	33.3%
Geb. Stat:	2
Nageslag:	
Soort:	

Querskap	Waar	Noer
DNS		
Geneties		

JN 200007
SKAAPVLEI RAM JN 200007

JN 180001
SKAAPVLEI EWE N180001

JN 160022
SKAAPVLEI RAM JN 160022

JN 180001
SKAAPVLEI EWE N180001

JN 160008
SKAAPVLEI OOI JN 160008

Growth			Reproduksie			
Spn. Dr.	Spn. Mat.	Na-Spn.	GLS	T/W	DEL	LP
92	103	93	100	100	114	114
00%	48%	20%	30%	30%	28%	20%

LOGIX
EBV Analyse 2023-10-05

VERKOPER OPMERKINGS:

Logix Merit Index	102
Growth Index	97
Reproduksie Index	109

LOT NR 35				
Verkoper	Beskrywing	Aantal	Koper	Prys
Skaapvlei Dormers	Dormer Ram SP	1		

*JN 22.64

*INENTINGS / DOSSEERINGS : BLOUTONG A B C, MULTI



J.J. NEL & SEUN
Lobby Grey Eastern Cape
vicktorj@psnet.co.za

JN 220064
SKAAPVLEI RAM JN 220064

Rudstboek	SP
Grb. dsm	2022-08-19
Oud.	12 jaar
Iseling	37%
Grb. Satus	2
Hegseling	
Gom	

JN 200007
SKAAPVLEI RAM JN 200007

Ouerskap / Year / Moer	
DHS	
Genomies	

JN 200008
SKAAPVLEI DOI JN 200008

DE 190043
AAN DE VALLE RAM DE 190043

JN 180001
SKAAPVLEI FVE JN 180001

DE 190043
AAN DE VALLE RAM DE 190043

JN 180001
SKAAPVLEI FVE JN 180001

Groot			Reproduksie			
Spr. Dv.	Spr. Mac.	Na. Spr.	GLS	TWW	DEL	LP
101	95	101	98	98	117	109
50%	4%	23%	7%	2%	26%	0%

LOGIX
EBV Analyse 2023-10-05

Logix Meriete Indeks	105
Groot Indeks	102
Reproduksie Indeks	105

VERKOPER OPMERKINGS:

LOT NR 36				
Verkoper	Beskrywing	Aantal	Koper	Prys
Witgezicht Dorpers	Dorper Ram Kommersieel	1		

*INENTINGS / DOSSEERINGS : MULTIVAX P PLUS, BLOEDNIER, REV 1

LOT NR 37				
Verkoper	Beskrywing	Aantal	Koper	Prys
Witgezicht Dorpers	Dorper Ram Kommersieel	1		

*INENTINGS / DOSSEERINGS : MULTIVAX P PLUS, BLOEDNIER, REV 1

LOT NR 38				
Verkoper	Beskrywing	Aantal	Koper	Prys
Witgezicht Dorpers	Dorper Ram Kommersieel	1		

*INENTINGS / DOSSEERINGS : MULTIVAX P PLUS, BLOEDNIER, REV 1

LOT NR 38A				
Verkoper	Beskrywing	Aantal	Koper	Prys
Witgezicht Dorpers	Dorper Ram Kommersieel	1		

*INENTINGS / DOSSEERINGS : MULTIVAX P PLUS, BLOEDNIER, REV 1

LOT NR 38B				
Verkoper	Beskrywing	Aantal	Koper	Prys
Witgezicht Dorpers	Dorper Ram Kommersieel	1		

*INENTINGS / DOSSEERINGS : MULTIVAX P PLUS, BLOEDNIER, REV 1

LOT NR 39				
Verkoper	Beskrywing	Aantal	Koper	Prys
Muldersbank Meatmaster	Meatmaster Ram Kudde	1		

*INENTINGS / DOSSEERINGS : MULTIVAX P

LOT NR 40				
Verkoper	Beskrywing	Aantal	Koper	Prys
Muldersbank Meatmaster	Meatmaster Ram Kudde	1		

*INENTINGS / DOSSEERINGS : MULTIVAX P

LOT NR 41				
Verkoper	Beskrywing	Aantal	Koper	Prys
Muldersbank Meatmaster	Meatmaster Ram Kudde	1		

*INENTINGS / DOSSEERINGS : MULTIVAX P

LOT NR 42				
Verkoper	Beskrywing	Aantal	Koper	Prys
Muldersbank Meatmaster	Meatmaster Ram Kudde	1		

*INENTINGS / DOSSEERINGS : MULTIVAX P

LOT NR 43				
Verkoper	Beskrywing	Aantal	Koper	Prys
Muldersbank Meatmaster	Meatmaster Ram Kudde	1		

*INENTINGS / DOSSEERINGS : MULTIVAX P

LOT NR 44				
Verkoper	Beskrywing	Aantal	Koper	Prys
Muldersbank Meatmaster	Meatmaster Ram Kudde	1		

*INENTINGS / DOSSEERINGS : MULTIVAX P

LOT NR 45				
Verkoper	Beskrywing	Aantal	Koper	Prys
Muldersbank Meatmaster	Meatmaster Ram Kudde	1		

*INENTINGS / DOSSEERINGS : MULTIVAX P

LOT NR 46				
Verkoper	Beskrywing	Aantal	Koper	Prys
Muldersbank Meatmaster	Meatmaster Ram Kudde	1		

*INENTINGS / DOSSEERINGS : MULTIVAX P

LOT NR 52				
Verkoper	Beskrywing	Aantal	Koper	Prys
Marhet Dormers	Dormer Ram Kudde	1		

*MGV22 0005

*INENTINGS / DOSSEERINGS : ONTWURM, IVERMAX, TRIOTIC



**Sales Catalogue Herd Rams / Ewes / Verkoopskatalogus Kudderamme / Ooie DORMER
Progeny not for Registration / Nageslag nie vir Registrasie**

Compiled by the South African Stud Book Association and Logix Small Stock. Pedigree- and Performance data certified correct
Saamgestel deur die Suid-Afrikaanse Stamboekvereniging en Logix Kleinvee, Stamboom- en Prestasiedata korrek gesertifiseer



Rams / Ramme

Animal ID Dier ID	Birth Date Geb. Datum	Status GEM	Wean Speen				Post Wean Naaspeen				NLW% GLS%	VR SFS SD	Own Lamb Record / Eie lamrekord Dam lamb record / Moer lamrekord						Buyer comments/price Koper opmerking/prys			
			Ind	Dir	Acc	Acc	Ind	Dir	Acc	Acc			1st	ILP	TL	LB	LS	MLI		EPI	Sire / Vaar	Dam / Moer
0703663 MARHET DORMERS, POSBUS 269, GROOT BRAKRIVIER, 6525																						
MGV 22 0005	02	LMB	97	-1.66	87	0.23	18	87	86	-2.4	95	-6.12	52.1	335	2	3	2	98	98	RM 190040 (01)	MGV 180027 (01)	RM 170030 RM 180005
Comment: Opmerking:																						

LOT NR 53				
Verkoper	Beskrywing	Aantal	Koper	Prys
Marhet Dormers	Dormer Ram Kudde	1		

*MGV22 0014

*INENTINGS / DOSSERINGS : ONTWURM, IVERMAX, TRIOTIC

Logix
Kleiner
Small Stock

Sales Catalogue Herd Rams / Ewes / Verkoopskatalogus Kudderamme / Ooie DORMER
Progeny not for Registration / Nageslag nie vir Registrasie nie

Compiled by the South African Stud Book Association and Logix Small Stock, Pedigree- and Performance data certified correct
Saamgestel deur die Suid-Afrikaanse Stamboekvereniging en Logix Kleinvee, Stamboum- en Prestasiedata korrek gesertifiseer



Rams / Ramme

Animal ID Dier ID	Birth Date Geb. Datum	Status GEN	Wean Speen			Post Wean Naspeen			NLRW% GLS%	VR SFS SD	Own Lamb Record / Eie lamrekord Dam lamb record / Moer lamrekord						Sire / Vaar Status			Dam / Moer Status			Buyer comment/price Koper opmerking/prys
			Ind	Dir	Acc	Ind	Dir	Acc			1st	ILP	TL	LB	LS	MLI	EPI	Sire / Vaar	Dam / Moer	Sire / Vaar	Dam / Moer		
0703663 MARHET DORMERS, POSBUS 269, GROOT BRAKRIVIER, 6525																							
MGV 22 0014	01	LMB	103	-58	45	0.6	186	33	-1.13	29	52.4	296	2	2	2	104	98	RM 190040 (01)	MGV 180015 (01)				
	12/09/2022	NFR																RM 170030	RM 180003	RM 170030			
Comment: Opmerking:																							

LOT NR 54				
Verkoper	Beskrywing	Aantal	Koper	Prys
Marhet Dormers	Dormer Ram Kudde	1		

*MGV22 0021

*INENTINGS / DOSSERINGS : ONTWURM, IVERMAX, TRIOTIC

Logix
Kleiner
Small Stock

Sales Catalogue Herd Rams / Ewes / Verkoopskatalogus Kudderamme / Ooie DORMER
Progeny not for Registration / Nageslag nie vir Registrasie nie

Compiled by the South African Stud Book Association and Logix Small Stock, Pedigree- and Performance data certified correct
Saamgestel deur die Suid-Afrikaanse Stamboekvereniging en Logix Kleinvee, Stamboum- en Prestasiedata korrek gesertifiseer



Rams / Ramme

Animal ID Dier ID	Birth Date Geb. Datum	Status GEN	Wean Speen			Post Wean Naspeen			NLRW% GLS%	VR SFS SD	Own Lamb Record / Eie lamrekord Dam lamb record / Moer lamrekord						Sire / Vaar Status			Dam / Moer Status			Buyer comment/price Koper opmerking/prys
			Ind	Dir	Acc	Ind	Dir	Acc			1st	ILP	TL	LB	LS	MLI	EPI	Sire / Vaar	Dam / Moer	Sire / Vaar	Dam / Moer		
0703663 MARHET DORMERS, POSBUS 269, GROOT BRAKRIVIER, 6525																							
MGV 22 0021	02	LMB	97	-1.77	48	0.14	106	30	-4.06	17	53.0	287	2	3	2	96	98	W 190064 (01)	MGV 180028 (01)				
	29/09/2022	NFR																J 160364	W 160709				
Comment: Opmerking:																							

LOT NR 55				
Verkoper	Beskrywing	Aantal	Koper	Prys
Marhet Dormers	Dormer Ram Kudde	1		

*MGV22 0025

*INENTINGS / DOSSERINGS : ONTWURM, IVERMAX, TRIOTIC

Logix
Kleiner
Small Stock

Sales Catalogue Herd Rams / Ewes / Verkoopskatalogus Kudderamme / Ooie DORMER
Progeny not for Registration / Nageslag nie vir Registrasie nie

Compiled by the South African Stud Book Association and Logix Small Stock, Pedigree- and Performance data certified correct
Saamgestel deur die Suid-Afrikaanse Stamboekvereniging en Logix Kleinvee, Stamboum- en Prestasiedata korrek gesertifiseer



Rams / Ramme

Animal ID Dier ID	Birth Date Geb. Datum	Status GEN	Wean Speen			Post Wean Naspeen			NLRW% GLS%	VR SFS SD	Own Lamb Record / Eie lamrekord Dam lamb record / Moer lamrekord						Sire / Vaar Status			Dam / Moer Status			Buyer comment/price Koper opmerking/prys
			Ind	Dir	Acc	Ind	Dir	Acc			1st	ILP	TL	LB	LS	MLI	EPI	Sire / Vaar	Dam / Moer	Sire / Vaar	Dam / Moer		
0703663 MARHET DORMERS, POSBUS 269, GROOT BRAKRIVIER, 6525																							
MGV 22 0025	02	LMB	103	-78	48	0.74	187	32	-1.31	28	52.3	286	2	3	3	100	105	RM 190040 (01)	MGV 180021 (01)				
	09/09/2022	NFR																RM 170030	RM 180005				
Comment: Opmerking:																							

LOT NR 56				
Verkoper	Beskrywing	Aantal	Koper	Prys
Marhet Dormers	Dormer Ram Kudde	1		

*MGV22 0026

*INENTINGS / DOSSERINGS : ONTWURM, IVERMAX, TRIOTIC

Logix
Kleinvee
Small Stock

**Sales Catalogue Herd Rams / Ewes / Verkoopskatalogus Kudderamme / Ooie DORMER
Progeny not for Registration / Nageslag nie vir Registrasie nie**

Compiled by the South African Stud Book Association and Logix Small Stock. Pedigree- and Performance data certified correct
Saamgestel deur die Suid-Afrikaanse Stamboekvereniging en Logix Kleinvee. Stamboom- en Prestasiedata korrek gesertifiseer



Rams / Ramme

Animal ID Dier ID	Birth Date Geb. Datum	Status GEM	Wean Speen		Post Wean Naspeen		NLW% GLS%	VR SP% SD	Own Lamb Record / Eie lamrekord Dam lamb record / Moer lamrekord						Sire / Vaar Status Sire / Vaar	Dam / Moer Status Sire / Vaar	Buyer comment/price Koper opmerking/prys		
			Ind	Dir	Acc	Acc			Ind	Dir	Acc	Acc	1st	ILP				TL	LB
0703663 MARHET DORMERS, POSBUS 269, GROOT BRAKRIVIER, 6525																			
MGV 22 0026	02	LMB	102	-82	46	0.75	107	32	13	52.3	286	2	3	3	100	106	RM 190040 (01) RM 170000	MGV 180021 (01) RM 180005	
Comment: Opmerking:																			

LOT NR 57				
Verkoper	Beskrywing	Aantal	Koper	Prys
Marhet Dormers	Dormer Ram Kudde	1		

*MGV22 0027

*INENTINGS / DOSSERINGS : ONTWURM, IVERMAX, TRIOTIC

Logix
Kleinvee
Small Stock

**Sales Catalogue Herd Rams / Ewes / Verkoopskatalogus Kudderamme / Ooie DORMER
Progeny not for Registration / Nageslag nie vir Registrasie nie**

Compiled by the South African Stud Book Association and Logix Small Stock. Pedigree- and Performance data certified correct
Saamgestel deur die Suid-Afrikaanse Stamboekvereniging en Logix Kleinvee. Stamboom- en Prestasiedata korrek gesertifiseer



Rams / Ramme

Animal ID Dier ID	Birth Date Geb. Datum	Status GEM	Wean Speen		Post Wean Naspeen		NLW% GLS%	VR SP% SD	Own Lamb Record / Eie lamrekord Dam lamb record / Moer lamrekord						Sire / Vaar Status Sire / Vaar	Dam / Moer Status Sire / Vaar	Buyer comment/price Koper opmerking/prys		
			Ind	Dir	Acc	Acc			Ind	Dir	Acc	Acc	1st	ILP				TL	LB
0703663 MARHET DORMERS, POSBUS 269, GROOT BRAKRIVIER, 6525																			
MGV 22 0027	01	LMB	97	-106	40	0.38	103	30	12	52.3	3/5	2	2	1	100	93	RM 190040 (01) RM 170000	MGV 180006 (01) RM 180005	
Comment: Opmerking:																			

LOT NR 58				
Verkoper	Beskrywing	Aantal	Koper	Prys
Marhet Dormers	Dormer Ram Kudde	1		

*MGV22 001

*INENTINGS / DOSSERINGS : ONTWURM, IVERMAX, TRIOTIC

LOT NR 59				
Verkoper	Beskrywing	Aantal	Koper	Prys
Steynberg Boerdery Trust	Dormer Ram Kudde	1		

*2211

*INENTINGS / DOSSERINGS : BLOEDNIER, GEBLOK, VALBAZEN ULTRA

LOT NR 60				
Verkoper	Beskrywing	Aantal	Koper	Prys
Steynberg Boerdery Trust	Dormer Ram Kudde	1		

*2213

*INENTINGS / DOSSERINGS : BLOEDNIER, GEBLOK, VALBAZEN ULTRA

LOT NR 61				
Verkoper	Beskrywing	Aantal	Koper	Prys
Steynberg Boerdery Trust	Dormer Ram Kudde	1		

*2215

*INENTINGS / DOSSERINGS : BLOEDNIER, GEBLOK, VALBAZEN ULTRA

LOT NR 62				
Verkoper	Beskrywing	Aantal	Koper	Prys
Steynberg Boerdery Trust	Dormer Ram Kudde	1		

*2216

*INENTINGS / DOSSERINGS : BLOEDNIER, GEBLOK, VALBAZEN ULTRA

LOT NR 63				
Verkoper	Beskrywing	Aantal	Koper	Prys
Steynberg Boerdery Trust	Dormer Ram Kudde	1		

*2221

*INENTINGS / DOSSERINGS : BLOEDNIER, GEBLOK, VALBAZEN ULTRA

LOT NR 64				
Verkoper	Beskrywing	Aantal	Koper	Prys
Steynberg Boerdery Trust	Dormer Ram Kudde	1		

*2222

*INENTINGS / DOSSERINGS : BLOEDNIER, GEBLOK, VALBAZEN ULTRA

LOT NR 65				
Verkoper	Beskrywing	Aantal	Koper	Prys
Steynberg Boerdery Trust	Dormer Ram Kudde	1		

*2142

*INENTINGS / DOSSERINGS : BLOEDNIER, GEBLOK, VALBAZEN ULTRA

LOT NR 66				
Verkoper	Beskrywing	Aantal	Koper	Prys
Steynberg Boerdery Trust	Dormer Ram Kudde	1		

*2113

*INENTINGS / DOSSERINGS : BLOEDNIER, GEBLOK, VALBAZEN ULTRA

LOT NR 67				
Verkoper	Beskrywing	Aantal	Koper	Prys
Steynberg Boerdery Trust	Dormer Ram Kudde	1		

*2145

*INENTINGS / DOSSERINGS : BLOEDNIER, GEBLOK, VALBAZEN ULTRA

LOT NR 69				
Verkoper	Beskrywing	Aantal	Koper	Prys
FB Damaras	Damara Ram Kommersieël	1		

*INENTINGS / DOSSERINGS : BLOEDNIER, PASTEURRELA

LOT NR 70				
Verkoper	Beskrywing	Aantal	Koper	Prys
Sanctuary Dormers	Dormer Ooi SP met tweeling	1 + 2		

*FCC 22196

*Inentings / Doserings : Ivomex & Oneshot 7



F.C. CLOETE
Chabok, Eastern Cape
f.cloete@fvs.co.za

FCC 220196
SANCTUARY EWE FCC220196

Kuddeboek: SP
Geb. dte: 2022-05-28
Oud: 1,4 jaar
Helling: 6,77%
Geb. Status: 2
DEL: LP: GP:

FCC 200215
SANCTUARY RAM FCC200215
Duerslag: Weer Noer
DNS
Geneties

FCC 190079
SANCTUARY EWE FCC190079
Geb. dte: 2021-12-04
Oud: 2,1 jaar
Helling: 6,77%
Geb. Status: 2
DEL: LP: GP:

JB 180054
JOHANNI RAM JB180054

FCC 160112
SANCTUARY OOI FCC 160112
Geb. dte: 2018-04-18
Oud: 4,1 jaar
Helling: 6,77%
Geb. Status: 2
DEL: LP: GP:

FCC 160292
SANCTUARY RAM FCC 160292

FCC 160229
SANCTUARY OOI FCC 160229
Geb. dte: 2018-04-18
Oud: 4,1 jaar
Helling: 6,77%
Geb. Status: 2
DEL: LP: GP:

JOHANNI OOI JB 100034
HE. (LP: 1) (SP: 1)
Lambd: 1 (Lamb: 1) (Lamb: 1)

EVERSAR RAM CH140127
HE. (LP: 1) (SP: 1)
Lambd: 1 (Lamb: 1) (Lamb: 1)

SANCTUARY OOI FCC 120087
HE. (LP: 1) (SP: 1)
Lambd: 1 (Lamb: 1) (Lamb: 1)

EVERSAR RAM CH150069
HE. (LP: 1) (SP: 1)
Lambd: 1 (Lamb: 1) (Lamb: 1)

SANCTUARY EWE FCC140170
HE. (LP: 1) (SP: 1)
Lambd: 1 (Lamb: 1) (Lamb: 1)

EVERSAR RAM CH150069
HE. (LP: 1) (SP: 1)
Lambd: 1 (Lamb: 1) (Lamb: 1)

SANCTUARY EWE FCC140283
HE. (LP: 1) (SP: 1)
Lambd: 1 (Lamb: 1) (Lamb: 1)

Groot			Reproduksie			
Spn. Dir.	Spn. Mac.	Ne-Spn.	GLS	TWV	CEL	LP
95	108	98	105	105	97	93
50%	4%	5%	33%	33%	33%	29%

LOGIX
EBV Analyse 2023-10-05

Logix Meriete Indeks: 104
Groot Indeks: 102
Reproduksie Indeks: 110

VERKOPER OPMERKINGS:

LOT NR 71				
Verkoper	Beskrywing	Aantal	Koper	Prys
Sanctuary Dormers	Dormer Ooi Dragtig SP	1		

*FCC 22073

*DRAGTIG VAN MONSTER FCC19089

*Inentings / Doserings : Ivomex & Oneshot 7



F.C. CLOETE
Chabok, Eastern Cape
f.cloete@fvs.co.za

FCC 220073
SANCTUARY EWE FCC220073

More Book: SP
Birth dte: 2022-03-10
Age: 1,6 years
Helling: 8,75%
Birth Sex: 2
AFL: LP: ER:

FCC 190089
SANCTUARY RAM FCC190089
Parentage: Sire Dam
DNA
Genetic

FCC 200168
SANCTUARY OOI FCC 200168
HE. (LP: 1) (SP: 1)
Lambd: 1 (Lamb: 2) (Lamb: 2)

FCC 180004
SANCTUARY RAM FCC180004

FCC 170202
SANCTUARY OOI FCC 170202
HE. (LP: 1) (SP: 1)
Lambd: 1 (Lamb: 1) (Lamb: 1)

JB 180054
JOHANNI RAM JB180054

FCC 170154
SANCTUARY OOI FCC 170154
HE. (LP: 1) (SP: 1)
Lambd: 1 (Lamb: 1) (Lamb: 1)

SANCTUARY RAM FCC 160282
HE. (LP: 1) (SP: 1)
Lambd: 1 (Lamb: 1) (Lamb: 1)

SANCTUARY OOI FCC 160289
HE. (LP: 1) (SP: 1)
Lambd: 1 (Lamb: 1) (Lamb: 1)

JOHANNI RAM JB 150029
HE. (LP: 1) (SP: 1)
Lambd: 1 (Lamb: 1) (Lamb: 1)

SANCTUARY OOI FCC 130346
HE. (LP: 1) (SP: 1)
Lambd: 1 (Lamb: 1) (Lamb: 1)

JOHANNI OOI JB 100034
HE. (LP: 1) (SP: 1)
Lambd: 1 (Lamb: 1) (Lamb: 1)

EVERSAR RAM CH150069
HE. (LP: 1) (SP: 1)
Lambd: 1 (Lamb: 1) (Lamb: 1)

SANCTUARY EWE FCC140462
HE. (LP: 1) (SP: 1)
Lambd: 1 (Lamb: 1) (Lamb: 1)

Growth			Reproduction			
Wt. Dir.	Waan Mac.	Post. Wt.	NUV	TWV	AFL	LP
111	111	107	92	92	99	98
60%	4%	33%	32%	32%	33%	2%

LOGIX
EBV Analyse 2023-10-05

Logix Merit Index: 112
Growth Index: 119
Reproduction Index: 106

SELLER REMARKS:

LOT NR 72				
Verkoper	Beskrywing	Aantal	Koper	Prys
Sanctuary Dormers	Dormer Ooi SP met lam	1 + 1		

*FCC 22037

*Inentings / Doserings : Ivomex & Oneshot 7



F.C. CLOETE
Chabok, Eastern Cape
f.cloete@fvs.co.za

FCC 220037
SANCTUARY EWE FCC220037

More Book: SP
Birth dte: 2022-03-04
Age: 1,6 years
Helling: 10,07%
Birth Sex: 1
AFL: LP: ER:

FCC 190089
SANCTUARY RAM FCC190089
Parentage: Sire Dam
DNA
Genetic

FCC 200232
SANCTUARY OOI FCC 200232
HE. (LP: 1) (SP: 1)
Lambd: 1 (Lamb: 1) (Lamb: 1)

FCC 180004
SANCTUARY RAM FCC180004

FCC 170202
SANCTUARY OOI FCC 170202
HE. (LP: 1) (SP: 1)
Lambd: 1 (Lamb: 1) (Lamb: 1)

JB 180054
JOHANNI RAM JB180054

FCC 180114
SANCTUARY OOI FCC180114
HE. (LP: 1) (SP: 1)
Lambd: 1 (Lamb: 1) (Lamb: 1)

SANCTUARY RAM FCC 160282
HE. (LP: 1) (SP: 1)
Lambd: 1 (Lamb: 1) (Lamb: 1)

SANCTUARY OOI FCC 160289
HE. (LP: 1) (SP: 1)
Lambd: 1 (Lamb: 1) (Lamb: 1)

JOHANNI RAM JB 150029
HE. (LP: 1) (SP: 1)
Lambd: 1 (Lamb: 1) (Lamb: 1)

SANCTUARY OOI FCC 130346
HE. (LP: 1) (SP: 1)
Lambd: 1 (Lamb: 1) (Lamb: 1)

JOHANNI OOI JB 100034
HE. (LP: 1) (SP: 1)
Lambd: 1 (Lamb: 1) (Lamb: 1)

EVERSAR RAM CH150069
HE. (LP: 1) (SP: 1)
Lambd: 1 (Lamb: 1) (Lamb: 1)

SANCTUARY EWE FCC140187
HE. (LP: 1) (SP: 1)
Lambd: 1 (Lamb: 1) (Lamb: 1)

Growth			Reproduction			
Wt. Dir.	Waan Mac.	Post. Wt.	NUV	TWV	AFL	LP
109	116	106	89	89	102	100
60%	4%	48%	32%	32%	32%	23%

LOGIX
EBV Analyse 2023-10-05

Logix Merit Index: 111
Growth Index: 119
Reproduction Index: 106

SELLER REMARKS:

LOT NR 73				
Verkoper	Beskrywing	Aantal	Koper	Prys
Sanctuary Dormers	Dormer Ooi SP met tweeling	1 + 2		

*FCC 22019

*Inentings / Doserings : Ivomex & Oneshot 7



F.C. CLOETE
Onder: Eastern Cape
fjcloete@live.com

FCC 220019
SANCTUARY EWE FCC220019

Herd Book: SP
Birth date: 2022-03-01
Age: 1.6 years
Inbreed %: 5.45%
Birth Sex: 2
ARL: LP: EP:

SWH 190307
SWH RAM SWH190307

SWH 180008
SWH RAM SWH180008

JB 160195
JOHANNI EWE JB160195

FCC 160292
SANCTUARY RAM FCC 160292

FCC 180632
SANCTUARY EWE FCC180632

FCC 160078
SANCTUARY EWE FCC160078

JOHANNI RAM JB160040
JOHANNI OOI JB 160039
JOHANNI RAM JB 160074 BOKKAMP
JOHANNI OOI JB 160045
EVERSAR RAM CH150069
SANCTUARY EWE FCC160170
BROERVIER RAM OZ 18015

Growth			Reproduction			
Wt. Dir.	Wean. Hac.	Post. Wt.	NW	TW	ARL	LP
97	103	99	105	105	94	101
39%	46%	48%	36%	36%	32%	27%

Logix Merit Index **103**
Growth Index **102**
Reproduction Index **106**

SELLER REMARKS:

LOT NR 74				
Verkoper	Beskrywing	Aantal	Koper	Prys
Sanctuary Dormers	Dormer Ooi Dragtig SP	1		

*FCC 22179

*DRAGTIG VAN MONSTER FCC19089

*Inentings / Doserings : Ivomex & Oneshot 7



F.C. CLOETE
Onder: Eastern Cape
fjcloete@live.com

FCC 220179
SANCTUARY EWE FCC220179

Kuddeboek: SP
Geb. dnm: 2022-04-22
Oud: 1.3 jaar
Inbreed %: 10.42%
Geb. Soesl: 2
ARL: LP: EP:

FCC 200253
SANCTUARY RAM FCC200253

JB 180054
JOHANNI RAM JB180054

FCC 180369
SANCTUARY RAM FCC180369

FCC 180510
SANCTUARY RAM FCC180510

FCC 180148
SANCTUARY EWE FCC180148

FCC 180258
SANCTUARY EWE FCC180258

JOHANNI RAM JB160040
JOHANNI OOI JB 160034
WELPIC RAM JB170054
SANCTUARY OOI FCC 170021
WELPIC RAM JB170054
SANCTUARY OOI FCC 160293
SANCTUARY RAM FCC 160262

Groot			Reproduksie			
Sp. Dir.	Sp. Hac.	Na. Sp.	GLS	TW	DEL	LP
107	116	105	98	98	94	102
53%	49%	4%	33%	33%	3%	22%

Logix Meriete Indeks **112**
Groot Indeks **117**
Reproduksie Indeks **111**

VERKOPER OPMERKINGS:

LOT NR 75				
Verkoper	Beskrywing	Aantal	Koper	Prys
Sanctuary Dormers	Dormer Ooi SP met tweeling	1 + 2		

*FCC 22045

*Inentings / Doserings : Ivomex & Oneshot 7



S. DUDA

FCC 220045
SANCTUARY EWE FCC220045

Herd Book: SP
Birth date: 2022-03-05
Age: 1.6 years
Inbreed %: 5.44%
Birth Sex: 1
ARL: LP: EP:

SWH 190307
SWH RAM SWH190307

SWH 180008
SWH RAM SWH180008

JB 160195
JOHANNI EWE JB160195

FCC 160292
SANCTUARY RAM FCC 160292

FCC 180626
SANCTUARY EWE FCC180626

FCC 160213
SANCTUARY OOI FCC 160213

JOHANNI RAM JB160040
JOHANNI OOI JB 160039
JOHANNI RAM JB 160074 BOKKAMP
JOHANNI OOI JB 160045
EVERSAR RAM CH150069
SANCTUARY EWE FCC160170
EVERSAR RAM CH150069
SANCTUARY OOI FCC 160240

Growth			Reproduction			
Wt. Dir.	Wean. Hac.	Post. Wt.	NW	TW	ARL	LP
103	116	106	95	95	95	95
38%	44%	48%	35%	35%	32%	25%

Logix Merit Index **109**
Growth Index **114**
Reproduction Index **108**

SELLER REMARKS:

LOT NR 76				
Verkoper	Beskrywing	Aantal	Koper	Prys
Sanctuary Dormers	Dormer Ooi SP met lam	1 + 1		

*FCC 22054

*Inentings / Doserings : Ivomex & Oneshot 7



F.C. CLOETE
Onder: Eastern Cape
Hydro@fvc.co.za

FCC 220054
SANCTUARY EWE FCC220054

Kuddeboek: SP
Geb. dtn: 2022-08-05
Oud: 1,9 jaar
Inleing: 13,00%
Geb. Status: 2
OEL LP OR: 16,5m - -
Ged. 1
Lammes: 1
Gesp. 0

FCC 190089
SANCTUARY RAM FCC190089
Oud: 1,9 jaar
Inleing: 13,00%
Geb. Status: 2
OEL LP OR: 16,5m - -
Ged. 1
Lammes: 1
Gesp. 0

FCC 200329
SANCTUARY EWE FCC200329
Oud: 1,9 jaar
Inleing: 13,00%
Geb. Status: 2
OEL LP OR: 16,5m - -
Ged. 1
Lammes: 1
Gesp. 0

FCC 180004
SANCTUARY RAM FCC180004
Oud: 1,9 jaar
Inleing: 13,00%
Geb. Status: 2
OEL LP OR: 16,5m - -
Ged. 1
Lammes: 1
Gesp. 0

FCC 170202
SANCTUARY OOI FCC170202
Oud: 1,9 jaar
Inleing: 13,00%
Geb. Status: 2
OEL LP OR: 16,5m - -
Ged. 1
Lammes: 1
Gesp. 0

FCC 180184
SANCTUARY RAM FCC180184
Oud: 1,9 jaar
Inleing: 13,00%
Geb. Status: 2
OEL LP OR: 16,5m - -
Ged. 1
Lammes: 1
Gesp. 0

FCC 180061
SANCTUARY EWE FCC180061
Oud: 1,9 jaar
Inleing: 13,00%
Geb. Status: 2
OEL LP OR: 16,5m - -
Ged. 1
Lammes: 1
Gesp. 0

Groei			Reproduksie			
Spn. Dn.	Spn. Mac.	Na. Spn.	GLS	TWV	OEL	LP
111	102	107	98	98	109	101
58%	48%	52%	30%	30%	33%	27%

LOGIX
EBV Analyse 2023-10-05

Logix Meriete Indeks: 113
Groei Indeks: 114
Reproduksie Indeks: 108

VERKOPER OPMERKINGS:

LOT NR 77				
Verkoper	Beskrywing	Aantal	Koper	Prys
Sanctuary Dormers	Dormer Ooi SP met lam	1 + 1		

*FCC 22201

*Inentings / Doserings : Ivomex & Oneshot 7



F.C. CLOETE
Onder: Eastern Cape
Hydro@fvc.co.za

FCC 22201
SANCTUARY EWE FCC22201

Fund Book: SP
Birth date: 2022-05-29
Age: 1,4 years
Inleing: 16,5%
Birth Stat: 2
AHL LP ER: 14,3m - -
Lambd: 1
Lamb: 1
Hoand: 0

FCC 200238
SANCTUARY RAM FCC200238
Oud: 1,4 years
Inleing: 16,5%
Geb. Status: 2
AHL LP ER: 14,3m - -
Lambd: 1
Lamb: 1
Hoand: 0

FCC 180342
SANCTUARY OOI FCC180342
Oud: 1,4 years
Inleing: 16,5%
Geb. Status: 2
AHL LP ER: 14,3m - -
Lambd: 1
Lamb: 1
Hoand: 0

FCC 160292
SANCTUARY RAM FCC160292
Oud: 1,4 years
Inleing: 16,5%
Geb. Status: 2
AHL LP ER: 14,3m - -
Lambd: 1
Lamb: 1
Hoand: 0

FCC 180294
SANCTUARY EWE FCC180294
Oud: 1,4 years
Inleing: 16,5%
Geb. Status: 2
AHL LP ER: 14,3m - -
Lambd: 1
Lamb: 1
Hoand: 0

FCC 160289
SANCTUARY OOI FCC160289
Oud: 1,4 years
Inleing: 16,5%
Geb. Status: 2
AHL LP ER: 14,3m - -
Lambd: 1
Lamb: 1
Hoand: 0

Growth			Reproduction			
Wt. Dn.	Wcon. Mac.	Post. Wn.	NEW	TWV	AHL	LP
97	112	95	115	115	90	93
56%	46%	53%	36%	36%	32%	26%

LOGIX
EBV Analyse 2023-10-05

Logix Meriete Indeks: 110
Growth Indeks: 106
Reproduction Indeks: 119

SELLER REMARKS:

LOT NR 78				
Verkoper	Beskrywing	Aantal	Koper	Prys
Westmar	Dormer Ooi SP (DRAGTIG)	1		

*W20.10

*SLENDAL, BLOUTONG A B C, MULTIVAX P



WESTMAR DORMERS
Pretorius, Free State
07961827
wfc@wmar.com

W 200010
WM EWE W200010

Kuddeboek: SP
Geb. dtn: 2020-07-05
Oud: 3,3 jaar
Inleing: 5,45%
Geb. Status: 2
OEL LP OR: 22,4m - 95
Ged. 1
Lammes: 1
Gesp. 1

W 170093
WESTLEY RAM W170093
Oud: 3,3 jaar
Inleing: 5,45%
Geb. Status: 2
OEL LP OR: 22,4m - 95
Ged. 1
Lammes: 1
Gesp. 1

W 150072
WESTLEY OOI W 150072
Oud: 3,3 jaar
Inleing: 5,45%
Geb. Status: 2
OEL LP OR: 22,4m - 95
Ged. 1
Lammes: 1
Gesp. 1

CN 150069
EVERSAR RAM CN150069
Oud: 3,3 jaar
Inleing: 5,45%
Geb. Status: 2
OEL LP OR: 22,4m - 95
Ged. 1
Lammes: 1
Gesp. 1

FCC 160236
SANCTUARY OOI FCC160236
Oud: 3,3 jaar
Inleing: 5,45%
Geb. Status: 2
OEL LP OR: 22,4m - 95
Ged. 1
Lammes: 1
Gesp. 1

FCC 140386
SANCTUARY FHE FCC140386
Oud: 3,3 jaar
Inleing: 5,45%
Geb. Status: 2
OEL LP OR: 22,4m - 95
Ged. 1
Lammes: 1
Gesp. 1

Groei			Reproduksie			
Spn. Dn.	Spn. Mac.	Na. Spn.	GLS	TWV	OEL	LP
92	124	97	90	90	100	95
62%	58%	34%	45%	45%	42%	30%

LOGIX
EBV Analyse 2023-10-05

Logix Meriete Indeks: 101
Groei Indeks: 106
Reproduksie Indeks: 107

VERKOPER OPMERKINGS:

LOT NR 78A				
Verkoper	Beskrywing	Aantal	Koper	Prys
Westmar	Dormer Ooi Kommerseeel (DRAGTIG)	1		

*W22.10

*SLENDAL, BLOUTONG A B C, MULTIVAX P

LOT NR 79				
Verkoper	Beskrywing	Aantal	Koper	Prys
Westmar	Dormer Ooi SP (DRAGTIG)	1		

*W20.19

*SLENDAL, BLOUTONG A B C, MULTIVAX P



WESTMAR DORMERS
 Attention: Fico Skole
 07/31/1027
 w@westmar@gmail.com

W 200019
WM EWE W200019

Herd Book SP
 Birth date: 2020-07-09
 Age: 3.5 years
 Inbreeding: 8.16%
 Birth Sex: 2

APL LP EP
 12m: 423d 113

Lambod 2
Lamba 4
Horned 4

Parentage Sire: Dam

DNA

Genomic

W 170093 WESTLEY RAM W170093
 W 150072 WESTLEY OOI W150072
 W 160055 WESTLEY OOI W160055
 W 150014 WESTLEY OOI W150014

JB 140017 CHAVIS RAM JB 140017
 W 150072 WESTLEY OOI W150072
 RH 110005 MOLESCY RAM R 110005
 W 150014 WESTLEY OOI W150014

JOHANNI RAM JB 140014 BAKKAMP
 WESTLEY OOI JB 140014
 WESTLEY RAM W100216
 WESTLEY OOI W130021
 WESTLEY RAM W100223
 DORLOU OOI 1400077
 WESTLEY RAM W100216
 WESTLEY OOI W100005

Growth			Reproduction			
Wt. Dr.	Wen. Mat.	Post. Wt.	NEW	T/W	APL	LP
95	103	99	104	104	93	91
66%	6%	34%	4%	4%	4%	3%

LOGIX
 EBV Analysis 2023-10-05

SELLER REMARKS:

Logic Merit Index **100**
 Growth Index **100**
 Reproduction Index **104**

LOT NR 82				
Verkoper	Beskrywing	Aantal	Koper	Prys
Ducron	Dormer Ooi Kommerisieël	2		

LOT NR 85				
Verkoper	Beskrywing	Aantal	Koper	Prys
Welpic Dormers	Dormer Ooi Dragtig SP	1		

*JP22:0217

*DRAGTIG VAN JB21:0187 (ROCKY), LAMDATUM : VANAF NOVEMBER



WELPIC DORMERS
 Lady Grey Estate Cape
 082-461914
 w@welpic-mem@gmail.com

JP 220217
WELPIC EWE JP220217

Kuddebok SP
 Geb. date: 2022-04-25
 Oud: 1.5 jaar
 Inbreeding: 4.85%
 Geb. Status: 2

CEL LP SP
 - - -

DE 190043 AAN DE VALLE RAM DE 190043
 DE 150012 AAN DE VALLE OOI DE 150012
 JB 120119 D-AVR RAM JB 120119
 JN 120009 SKAARVILLE OOI JN 120009

DE 170332 AAN DE VALLE RAM DE 170332
 DE 150012 AAN DE VALLE OOI DE 150012
 JB 120119 D-AVR RAM JB 120119
 JN 120009 SKAARVILLE OOI JN 120009

AAN DE VALLE RAM DE 190250
 AAN DE VALLE OOI DE 160056
 AAN DE VALLE RAM DE 190117
 BES AGR EWE Q130477
 JOHANNI RAM JB 110047
 LEBUWOP OOI 160152
 DANIELLA RAM VZ 070180
 SKAARVILLE OOI JN 100019

Groeï			Reproduksie			
Spn. Dr.	Spn. Mat.	Na. Spn.	GLS	T/W	CEL	LP
109	93	107	86	86	118	107
64%	36%	4%	4%	4%	4%	2%

LOGIX
 EBV Analise 2023-10-05

VERKOPER OPMERKINGS:

Logic Meriete Indeks **105**
 Groei Indeks **109**
 Reprodukstie Indeks **96**

LOT NR 86				
Verkoper	Beskrywing	Aantal	Koper	Prys
Welpic Dormers	Dormer Ooi Oop SP	1		

*JP22:0105

*GEREED VIR RAM



WELPIC DORMERS
 Lady Grey Estate Cape
 082-461914
 w@welpic-mem@gmail.com

JP 220105
WELPIC EWE JP220105

Kuddebok SP
 Geb. date: 2022-04-10
 Oud: 1.5 jaar
 Inbreeding: 4.76%
 Geb. Status: 3

CEL LP SP
 - - -

DZ 170116 DROEYER RAM DZ 170116
 DZ 140210 DROEYER OOI DZ 140210
 J 150234 LEBUWOP RAM J 150234
 JP 190072 WELPIC OOI JP190072
 JP 110082 WELPIC OOI JP 110082

DZ 170116 DROEYER RAM DZ 170116
 DZ 140210 DROEYER OOI DZ 140210
 J 150234 LEBUWOP RAM J 150234
 JP 190072 WELPIC OOI JP190072
 JP 110082 WELPIC OOI JP 110082

DROEYER RAM DZ 070013
 DROEYER OOI DZ 050225
 DROEYER RAM DZ 100097
 DROEYER OOI DZ 130161
 LEBUWOP RAM J 130175
 LEBUWOP OOI J 120259
 DANIELLA RAM VZ 070180
 WELPIC OOI JP 090025

Groeï			Reproduksie			
Spn. Dr.	Spn. Mat.	Na. Spn.	GLS	T/W	CEL	LP
102	78	96	136	136	117	100
64%	36%	4%	4%	4%	4%	3%

LOGIX
 EBV Analise 2023-10-05

VERKOPER OPMERKINGS:

Logic Meriete Indeks **117**
 Groei Indeks **95**
 Reprodukstie Indeks **125**

LOT NR 87				
Verkoper	Beskrywing	Aantal	Koper	Prys
Welpic Dormers	Dormer Ooi Dragtig SP	1		

*JP22:0207

*DRAGTIG VAN JB21:0187 (ROCKY), LAMDATUM : VANAF NOVEMBER



WELPIC DORMERS
Lady Grey Estate Cape
08246934
welpicdormers@gmail.com

JP 220207
WELPIC EWE JP220207

Herf Boek: SP
Birth date: 2022-04-25
Age: 1.5 years
Inbreeding: 4.91%
Birth Stat: 3

AFL: EP: ER: - - -

DZ 170116
DROEYER RAM DZ 170116

DZ 140210
DROEYER OOI DZ 140210

JP 170002
WELPIC RAM JP170002

CN 100064
EVERSAR EWE CN100064

DROEYER RAM DZ 070013
DROEYER OOI DZ 060255

DROEYER RAM DZ 110097
DROEYER OOI DZ 130191

JOHARI RAM JB 110054
WELPIC EWE JP160025

EVERSAR RAM CN 060024
EVERSAR OOI CN040052

Growth			Reproduction			
Wt. Dr.	Waan. Hac.	Post. Wt.	NEW	TYW	AFL	EP
104	70	97	108	108	115	109
63%	5%	43%	46%	46%	45%	36%

LOGIX
EBV Analysis 2023-10-05

Logic Merit Index: **102**
Growth Index: **93**
Reproduction Index: **97**

SELLER REMARKS:

LOT NR 88				
Verkoper	Beskrywing	Aantal	Koper	Prys
Welpic Dormers	Dormer Ooi Oop SP	1		

*JP22:0124

*GEREED VIR RAM

*JB18:0008 CURVE BENDER DOGTER



WELPIC DORMERS
Lady Grey Estate Cape
08246934
welpicdormers@gmail.com

JP 220124
WELPIC EWE JP220124

Herf Boek: SP
Birth date: 2022-04-10
Age: 1.5 years
Inbreeding: 7.48%
Birth Stat: 2

AFL: EP: ER: - - -

JB 180008
JOHARI RAM JB 180008

JB 170005
JOHARI EWE JB 170005

JB 110054
JOHARI RAM JB 110054

JP 160001
WELPIC EWE JP160001

JP 110098
WELPIC OOI JP 110098

JAMUWI RAM K 130097
REMKUL OOI JT 140086

LEEUWKOOP RAM JB0133
JOHARI OOI JB 020036

EVERSAR RAM CN 090004
JOHARI OOI JB 030015

DANELLA RAM VZ 070029
WELPIC OOI JP 090078

Growth			Reproduction			
Wt. Dr.	Waan. Hac.	Post. Wt.	NEW	TYW	AFL	EP
105	78	109	127	127	101	92
64%	5%	45%	42%	42%	41%	32%

LOGIX
EBV Analysis 2023-10-05

Logic Merit Index: **111**
Growth Index: **98**
Reproduction Index: **113**

SELLER REMARKS:

LOT NR 89				
Verkoper	Beskrywing	Aantal	Koper	Prys
Welpic Dormers	Dormer Ooi Oop SP	1		

*JP22.0212

*GEREED VIR RAM



WELPIC DORMERS
Lady Grey Estate Cape
08246934
welpicdormers@gmail.com

JP 220212
WELPIC EWE JP220212

Herf Boek: SP
Birth date: 2022-04-25
Age: 1.5 years
Inbreeding: 5.22%
Birth Stat: 2

AFL: EP: ER: - - -

DZ 170116
DROEYER RAM DZ 170116

DZ 140210
DROEYER OOI DZ 140210

JP 170033
WELPIC RAM JP170033

CN 140062
EVERSAR EWE CN140062

DROEYER RAM DZ 070013
DROEYER OOI DZ 060255

DROEYER RAM DZ 110097
DROEYER OOI DZ 130191

JOHARI RAM JB 110054
WELPIC OOI JP160050

WINTERSHOEK RAM JS 100019
EVERSAR OOI CN 050000

Growth			Reproduction			
Wt. Dr.	Waan. Hac.	Post. Wt.	NEW	TYW	AFL	EP
106	79	99	106	106	117	96
63%	5%	40%	46%	45%	43%	36%

LOGIX
EBV Analysis 2023-10-05

Logic Merit Index: **106**
Growth Index: **99**
Reproduction Index: **102**

SELLER REMARKS:

LOT NR 90				
Verkoper	Beskrywing	Aantal	Koper	Prys
Welpic Dormers	Dormer Ooi Oop SP	1		

*JP22:0302

*GEREED VIR RAM



WELPIC DORMERS
Lady Grey, East of Cape
08234934
acj@weldormer@gmail.com

JP 220302
WELPIC EWE JP220302

Kuddeboek:	SP
Geb. dnm:	2022-09-12
Oud:	1,1 jaar
Intelig:	6,17%
Geb. Status:	1
CEL:	LP
OP:	

JP 230122
WELPIC RAM JP230122

Ouerskap / Year / Noer	
DNS	
Geneties	

JP 200011
WELPIC EWE JP200011

JP 160084
JOHANNI APOLLO

JP 140038
WELPIC EWE JP140038

DZ 140020
DORRIVER RAM DZ140020

JP 150104
WELPIC OOI JP150104

JOHANNI RAM JB 140104

JOHANNI OOI JB 120104

JOHANNI RAM JB 120103

DORRIVER OOI AD 080104

JOHANNI RAM JB 110034

DORRIVER OOI DZ 100001

Groeï			Reproduksie			
Spn. Dn.	Spn. Mac.	Na. Spn.	GLS	TWW	CEL	ILP
92	105	92	86	86	81	103
37%	44%	38%	38%	38%	36%	37%

LOGIX
EBV Analyse 2023-10-05

Logix Meriete Indeks	89
Groeï Indeks	98
Reproduksie Indeks	87

VERKOPER OPMERKINGS:

LOT NR 91				
Verkoper	Beskrywing	Aantal	Koper	Prys
Welpic Dormers	Dormer Ooi Oop SP	1		

*JP22:0223

*GEREED VIR RAM



WELPIC DORMERS
Lady Grey, East of Cape
08234934
acj@weldormer@gmail.com

JP 220223
WELPIC EWE JP220223

Kuddeboek:	SP
Geb. dnm:	2022-04-25
Oud:	1,5 jaar
Intelig:	4,59%
Geb. Status:	2
CEL:	LP
OP:	

DZ 170016
DORRIVER RAM DZ 170016

DZ 140210
DORRIVER OOI DZ 140210

DE 140029
AAN DE VALLE RAM DE140029

DE 190012
AAN DE VALLE OOI DE 190012

DE 150179
AAN DE VALLE OOI DE 150179

DORRIVER RAM DZ 070013

DORRIVER OOI DZ 040206

DORRIVER RAM DZ 110007

DORRIVER OOI DZ 130101

AAN DE VALLE RAM DE030102

AAN DE VALLE OOI DE020104

AAN DE VALLE RAM DE030010

BB AGRI OOI DJ 100106

Groeï			Reproduksie			
Spn. Dn.	Spn. Mac.	Na. Spn.	GLS	TWW	CEL	ILP
107	82	103	107	107	121	111
63%	36%	46%	46%	46%	44%	38%

LOGIX
EBV Analyse 2023-10-05

Logix Meriete Indeks	110
Groeï Indeks	101
Reproduksie Indeks	107

VERKOPER OPMERKINGS:

LOT NR 92				
Verkoper	Beskrywing	Aantal	Koper	Prys
Ruswater Dormers	Dormer Ooi SP	1		

*22-61



F.J. KRUGER
Ruswateraan, North West
082379887
ruswaterkruger@gmail.com

RW 220061
RUSWATER OOI RW 220061

Kuddeboek:	SP
Geb. dnm:	2022-05-03
Oud:	1,5 jaar
Intelig:	6,6%
Geb. Status:	1
CEL:	LP
OP:	

JB 190017
DE AGRI RAM JB190017

W 140211
WESTLEY OOI W 140211

T 180004
ZERRERS RAM T180004

JB 140037
JOHANNI OOI JB 140037

WELPIC RAM JP160070

WELPIC EWE JP160074

TOP 3 RAM AS1600367

WESTLEY OOI W 100235

ZERRERS OOI T 140040

LEEUWIGOP RAM J 140025

KINKO RAM JS 100287

JOHANNI OOI JB 080029

Groeï			Reproduksie			
Spn. Dn.	Spn. Mac.	Na. Spn.	GLS	TWW	CEL	ILP
82	105	87	111	111	92	127
60%	46%	57%	33%	33%	32%	26%

LOGIX
EBV Analyse 2023-10-05

Logix Meriete Indeks	97
Groeï Indeks	88
Reproduksie Indeks	112

VERKOPER OPMERKINGS: Was by Ram JT210438. Natuurlike dekking. Lamdatum - 6 Feb 24

LOT NR 93				
Verkoper	Beskrywing	Aantal	Koper	Prys
Ruswater Dormers	Dormer Ooi SP	1		

*20-100



F.J. KRUGER
Rooftoevoorn, North West
082859657
ruswaterkruger@gmail.com

RW 200100
RUSWATER EWE RW200100

Parentage: SP
Birth date: 2020-07-28
Age: 3.2 years
Inbreeding: 4.11%
Birth Sex: 2

Wt.	LP	ER
16.9m	289d	92

Lambes	2
Lambes	2
Wentse	1

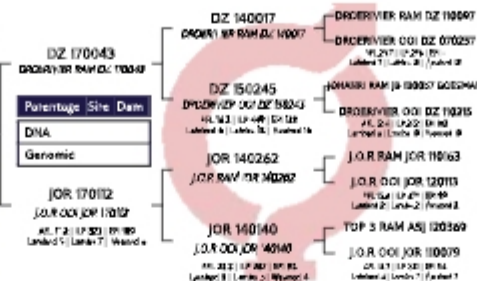

Growth			Reproduction			
Wt. Dr.	Wean Hac.	Post-We.	NW	TW	AFI	LP
89	101	90	92	92	102	126
63%	60%	39%	48%	48%	40%	39%

LOGIX
EBV Analysis 2023-10-05

Logic Merit Index	94
Growth Index	93
Reproduction Index	99

SELLER REMARKS: Was by Ram RW220079 (Top Ram op Ruswater Veiing). Natuurlike dekking. Lamdatum - 6 Feb 24

LOT NR 94				
Verkoper	Beskrywing	Aantal	Koper	Prys
Ruswater Dormers	Dormer Ooi SP	1		

*20-202



F.J. KRUGER
Rooftoevoorn, North West
082859657
ruswaterkruger@gmail.com

RW 200202
RUSWATER EWE RW200202

Parentage: SP
Birth date: 2020-10-09
Age: 3 years
Inbreeding: 7.57%
Birth Sex: 2

Wt.	LP	ER
18.7m	279d	115

Lambes	2
Lambes	3
Wentse	3

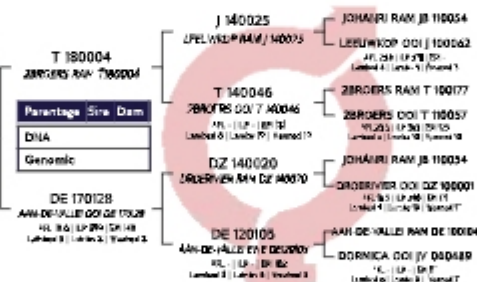

Growth			Reproduction			
Wt. Dr.	Wean Hac.	Post-We.	NW	TW	AFI	LP
90	101	92	91	91	94	101
66%	63%	63%	53%	53%	47%	30%

LOGIX
EBV Analysis 2023-10-05

Logic Merit Index	90
Growth Index	94
Reproduction Index	92

SELLER REMARKS: Was by Ram J210438. Natuurlike dekking. Lamdatum - 6 Feb 24

LOT NR 95				
Verkoper	Beskrywing	Aantal	Koper	Prys
Ruswater Dormers	Dormer Ooi SP met ramlam	1		

*RW210212



F.J. KRUGER
Rooftoevoorn, North West
082859657
ruswaterkruger@gmail.com

RW 210212
RUSWATER OOI RW 210212

Parentage: B
Birth date: 2021-09-05
Age: 2.1 years
Inbreeding: 7.02%
Birth Sex: 1

Wt.	LP	ER
22.4m	-	-

Lambes	1
Lambes	1
Wentse	0

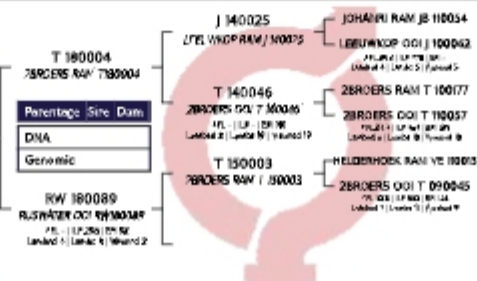

Growth			Reproduction			
Wt. Dr.	Wean Hac.	Post-We.	NW	TW	AFI	LP
68	115	64	92	92	109	110
37%	30%	34%	67%	48%	45%	20%

LOGIX
EBV Analysis 2023-10-05

Logic Merit Index	83
Growth Index	80
Reproduction Index	103

SELLER REMARKS: Met ramlam RW 230164.

LOT NR 96				
Verkoper	Beskrywing	Aantal	Koper	Prys
Ruswater Dormers	Dormer Ooi SP	1		

*22-33



F.J. KRUGER
Beskrywing: Wink Hout
062039667
ruswaterkruger@gmail.com

RW 220033
RUSWATER OOI RW 220033

Kuddeboek: SP
Geb. dnr: 2022-05-02
Oud: 1,5 jaar
Inkling: 4,23%
Geb. Status: 2
DEL LP OPI

IB 190462
NOVA BARLETTA RAM 190462
Geb. dnr: 2019-08-11
Oud: 4,5 jaar
Inkling: 4,23%
Geb. Status: 2
DEL LP OPI

RW 170064
RUSWATER OOI RW170064
Geb. dnr: 2017-08-11
Oud: 6,5 jaar
Inkling: 4,23%
Geb. Status: 2
DEL LP OPI

T 160050
ZBRORS RAM T 160050
Geb. dnr: 2016-08-11
Oud: 8,5 jaar
Inkling: 4,23%
Geb. Status: 2
DEL LP OPI

NB 160035
NOVA BARLETTA OOI NB 160035
Geb. dnr: 2016-08-11
Oud: 8,5 jaar
Inkling: 4,23%
Geb. Status: 2
DEL LP OPI

JB 150166
JOHANNI RAM JB 150166
Geb. dnr: 2015-08-11
Oud: 9,5 jaar
Inkling: 4,23%
Geb. Status: 2
DEL LP OPI

AP 130101
APENKOSTER BOSKOP RAM AP 130101
Geb. dnr: 2013-08-11
Oud: 11,5 jaar
Inkling: 4,23%
Geb. Status: 2
DEL LP OPI

Groot			Reproduksie			
Spn. Dn.	Spn. Hgt.	Na. Spn.	GLS	TWW	OEL	LP
89	104	89	97	97	111	93
63%	54%	50%	42%	47%	30%	30%

LOGIX
EBV Analyse 2023-10-05

Logix Meriete Indeks: **96**
Groot Indeks: **95**
Reproduksie Indeks: **104**

VERKOPER OPMERKINGS: Was by Ram RW2079. (Top Ram op Ruswater Veeing) Natuurlike dekking. Lamdatum - 6 Feb 24

LOT NR 97				
Verkoper	Beskrywing	Aantal	Koper	Prys
Skaapvlei Dormers	Dormer Ooi SP	1		

*JN 20.006

*LOOP BY RAM SL 0003

*INENTINGS / DOSSEERINGS : BLOUTONG A B C, MULTI



J.J. NEL & SEUN
Lasy Grey Eastern Cape
vickrj@para.co.za

JN 200006
SKAAPVLEI OOI JN 200006

Kuddeboek: SP
Geb. dnr: 2020-08-02
Oud: 3,2 jaar
Inkling: 4,75%
Geb. Status: 2
DEL LP OPI
24,4m - 103
Gelm: 1
Lammers: 2
Gebeen: 2

DE 190043
AAN DE VALLE RAM DE 190043
Geb. dnr: 2019-08-11
Oud: 4,5 jaar
Inkling: 4,75%
Geb. Status: 2
DEL LP OPI

JN 150006
SKAAPVLEI OOI JN 150006
Geb. dnr: 2015-08-11
Oud: 9,5 jaar
Inkling: 4,75%
Geb. Status: 2
DEL LP OPI

DE 170332
AAN DE VALLE RAM DE 170332
Geb. dnr: 2017-08-11
Oud: 7,5 jaar
Inkling: 4,75%
Geb. Status: 2
DEL LP OPI

DE 150012
AAN DE VALLE RAM DE 150012
Geb. dnr: 2015-08-11
Oud: 9,5 jaar
Inkling: 4,75%
Geb. Status: 2
DEL LP OPI

JN 120021
SKAAPVLEI RAM JN 120021
Geb. dnr: 2012-08-11
Oud: 12,5 jaar
Inkling: 4,75%
Geb. Status: 2
DEL LP OPI

JN 100109
SKAAPVLEI OOI JN 100109
Geb. dnr: 2010-08-11
Oud: 14,5 jaar
Inkling: 4,75%
Geb. Status: 2
DEL LP OPI

Groot			Reproduksie			
Spn. Dn.	Spn. Hgt.	Na. Spn.	GLS	TWW	OEL	LP
94	89	95	83	83	94	115
63%	6%	32%	4%	4%	43%	23%

LOGIX
EBV Analyse 2023-10-05

Logix Meriete Indeks: **86**
Groot Indeks: **92**
Reproduksie Indeks: **80**

VERKOPER OPMERKINGS:

LOT NR 98				
Verkoper	Beskrywing	Aantal	Koper	Prys
Skaapvlei Dormers	Dormer Ooi SP	1		

*JN 21.63

*DRAGTIG MET 2-LING VAN SL 0003 (LAM NOV 2023)

*INENTINGS / DOSSEERINGS : BLOUTONG A B C, MULTI



J.J. NEL & SEUN
Lasy Grey Eastern Cape
vickrj@para.co.za

JN 210063
SKAAPVLEI OOI JN 210063

Kuddeboek: SP
Geb. dnr: 2021-08-19
Oud: 2,2 jaar
Inkling: 11,5%
Geb. Status: 1
DEL LP OPI

JN 190009
SKAAPVLEI RAM JN 190009
Geb. dnr: 2019-08-11
Oud: 4,5 jaar
Inkling: 11,5%
Geb. Status: 1
DEL LP OPI

JN 180017
SKAAPVLEI RAM JN 180017
Geb. dnr: 2018-08-11
Oud: 5,5 jaar
Inkling: 11,5%
Geb. Status: 1
DEL LP OPI

T 180036
ZBRORS RAM T 180036
Geb. dnr: 2018-08-11
Oud: 5,5 jaar
Inkling: 11,5%
Geb. Status: 1
DEL LP OPI

JN 170002
SKAAPVLEI OOI JN 170002
Geb. dnr: 2017-08-11
Oud: 6,5 jaar
Inkling: 11,5%
Geb. Status: 1
DEL LP OPI

JN 160022
SKAAPVLEI RAM JN 160022
Geb. dnr: 2016-08-11
Oud: 7,5 jaar
Inkling: 11,5%
Geb. Status: 1
DEL LP OPI

JN 140015
SKAAPVLEI OOI JN 140015
Geb. dnr: 2014-08-11
Oud: 9,5 jaar
Inkling: 11,5%
Geb. Status: 1
DEL LP OPI

Groot			Reproduksie			
Spn. Dn.	Spn. Hgt.	Na. Spn.	GLS	TWW	OEL	LP
81	100	83	81	81	100	114
57%	43%	26%	37%	37%	28%	22%

LOGIX
EBV Analyse 2023-10-05

Logix Meriete Indeks: **81**
Groot Indeks: **86**
Reproduksie Indeks: **85**

VERKOPER OPMERKINGS:

LOT NR 99				
Verkoper	Beskrywing	Aantal	Koper	Prys
Skaapvlei Dormers	Dormer Ooi SP	1		

*JN 21.62

*DRAGTIG MET 2-LING VAN SL 0003 (LAM NOV 2023)

*INENTINGS / DOSSEERINGS : BLOUTONG A B C, MULTI



JJ. NEL & SEUN
Lady Grey, Eastern Cape
v. 08 31 00 00 00

JN 210062
SKAAPVLEI OOI JN 210062

Kategorie:	SP	
Geboortedatum:	2021-08-10	
Oud:	2,2 jaar	
Insigting:	22,08%	
Geboortestad:	1	
ARL	LP	EP
-	-	-

JN 190009
SKAAPVLEI RAM JN 190009

Ouerskap:	Van	Meer
DNS		
Geneties		

JN 170025
SKAAPVLEI OOI JN 170025

JN 120021
SKAAPVLEI RAM JN 120021

JN 120011
SKAAPVLEI OOI JN 120011

Groot			Reproduksie			
Sp. Dr.	Sp. Har.	Ha. Sp.	GLS	TWV	DEL	LP
78	95	80	73	73	94	122
57%	43%	10%	33%	33%	30%	23%

LOGIX
EBV Analysis 2023-10-05

Logix Meriete Indeks	72
Groes Indeks	80
Reproduksie Indeks	73

VERKOPER OPMERKINGS:

LOT NR 100				
Verkoper	Beskrywing	Aantal	Koper	Prys
Skaapvlei Dormers	Dormer Ooi SP	1		

*JN 21.36

*LOOP BY RAM SL 0003

*INENTINGS / DOSSEERINGS : BLOUTONG A B C, MULTI



JJ. NEL & SEUN
Lady Grey, Eastern Cape
v. 08 31 00 00 00

JN 210036
SKAAPVLEI OOI JN 210036

Herd Book:	SP	
Geboortedatum:	2021-08-12	
Oud:	2,2 years	
Insigting:	19,5%	
Geboortestad:	2	
ARL	LP	EP
-	-	-

JN 190019
SKAAPVLEI RAM JN 190019

Parentage:	Van	Dem
DNA		
Geneties		

JN 190026
SKAAPVLEI RAM JN 190026

JN 150007
SKAAPVLEI OOI JN 150007

T 180036
2BROERS RAM JN 180036

JN 160008
SKAAPVLEI RAM JN 160008

Growth			Reproduction			
Wt. Dr.	Wean Hac.	Post. Wt.	NWV	TWV	ARL	LP
84	109	83	77	77	90	116
50%	43%	6%	3%	3%	29%	24%

LOGIX
EBV Analysis 2023-10-05

Logix Merit Index	83
Growth Index	93
Reproduction Index	85

SELLER REMARKS:

LOT NR 101				
Verkoper	Beskrywing	Aantal	Koper	Prys
Skaapvlei Dormers	Dormer Ooi SP	1		

*JN 21.69

*DRAGTIG MET 1-LING VAN SL 0003 (LAM NOV 2023)

*INENTINGS / DOSSEERINGS : BLOUTONG A B C, MULTI



JJ. NEL & SEUN
Lady Grey, Eastern Cape
v. 08 31 00 00 00

JN 210069
SKAAPVLEI OOI JN 210069

Herd Book:	SP	
Geboortedatum:	2021-08-20	
Oud:	2,2 years	
Insigting:	16,94%	
Geboortestad:	2	
ARL	LP	EP
-	-	-

JN 190009
SKAAPVLEI RAM JN 190009

Parentage:	Van	Dem
DNA		
Geneties		

JN 180025
SKAAPVLEI RAM JN 180025

JN 150003
SKAAPVLEI OOI JN 150003

JN 170002
SKAAPVLEI OOI JN 170002

JN 160022
SKAAPVLEI RAM JN 160022

JN 150003
SKAAPVLEI OOI JN 150003

Growth			Reproduction			
Wt. Dr.	Wean Hac.	Post. Wt.	NWV	TWV	ARL	LP
81	106	83	77	77	89	122
57%	43%	5%	3%	3%	29%	23%

LOGIX
EBV Analysis 2023-10-05

Logix Merit Index	80
Growth Index	88
Reproduction Index	83

SELLER REMARKS:

LOT NR 102				
Verkoper	Beskrywing	Aantal	Koper	Prys
Skaapvlei Dormers	Dormer Ooi SP	1		

*JN 20.47

*LOOP BY RAM SL 0003

*INENTINGS / DOSSEERINGS : BLOUTONG A B C, MULTI



JJ. NEL & SEUN
Ledy Grey, Eastern Cape
v.c. jn@paard.co.za

JN 200047
SKAAPVLEI OOI JN 200047

Kruisboek	SP	
Geb. date	2020-08-10	
Oud.	3.2 jaar	
Intellig.	4.77%	
Geb. Status	2	
OEL	LP	OP
24.2m	-	10.5
Lemb.	1	
Lemb.	2	
Wentel	2	

Parentage: Sire: Dam: DNA: Genomic

Growth		Reproduction				
Wt. Dr.	Went. Mat.	Post-Wh.	NW	TW	AFL	LP
99	101	99	90	90	111	107
63%	6%	33%	40%	40%	43%	25%

LOGIX
EBV Analysis 2023-10-05

Logix Merit Index	100
Growth Index	102
Reproduction Index	99

SELLER REMARKS:

LOT NR 103				
Verkoper	Beskrywing	Aantal	Koper	Prys
Skaapvlei Dormers	Dormer Ooi SP	1		

*JN 21.57

*DRAGTIG MET 1-LING VAN SL 0003 (LAM NOV 2023)

*INENTINGS / DOSSEERINGS : BLOUTONG A B C, MULTI



JJ. NEL & SEUN
Ledy Grey, Eastern Cape
v.c. jn@paard.co.za

JN 210057
SKAAPVLEI OOI JN 210057

Kruisboek	SP	
Geb. date	2021-08-18	
Oud.	2.2 jaar	
Intellig.	24.34%	
Geb. Status	1	
OEL	LP	OP
-	-	-

Overloop: Year: Moer: DNS: Genomic

Groot		Reproduksie				
Spn. Dr.	Spn. Mat.	Na. Spn.	GLS	TWV	OEL	LP
79	100	81	66	66	104	114
57%	4%	5%	32%	32%	29%	22%

LOGIX
EBV Analyse 2023-10-05

Logix Meriete Indeks	72
Groot Indeks	83
Reproduksie Indeks	73

VERKOPER OPMERKINGS:

LOT NR 104				
Verkoper	Beskrywing	Aantal	Koper	Prys
Skaapvlei Dormers	Dormer Ooi SP	1		

*JN 21.31

*LOOP BY RAM SL 0003

*INENTINGS / DOSSEERINGS : BLOUTONG A B C, MULTI



JJ. NEL & SEUN
Ledy Grey, Eastern Cape
v.c. jn@paard.co.za

JN 210031
SKAAPVLEI OOI JN 210031

Kruisboek	SP	
Geb. date	2021-08-10	
Oud.	2.2 jaar	
Intellig.	25.27%	
Geb. Status	2	
OEL	LP	OP
-	-	-

Overloop: Year: Moer: DNS: Genomic

Groot		Reproduksie				
Spn. Dr.	Spn. Mat.	Na. Spn.	GLS	TWV	OEL	LP
88	98	86	68	68	90	113
56%	4%	5%	3%	3%	29%	23%

LOGIX
EBV Analyse 2023-10-05

Logix Meriete Indeks	77
Groot Indeks	91
Reproduksie Indeks	71

VERKOPER OPMERKINGS:

LOT NR 105				
Verkoper	Beskrywing	Aantal	Koper	Prys
Skaapvlei Dormers	Dormer Ooi SP	1		

*JN 21.58
 *DRAGTIG MET 1-LING VAN SL 0003 (LAM NOV 2023)
 *INENTINGS / DOSSEERINGS : BLOUTONG A B C, MULTI



J.J. NIEL & SEUN
Loy Grey Eastern Cape
vskn@pork.co.za

JN 210058
SKAAPVLEI OOI JN 210058

Kuddeboek: SP
 Geb. dtn: 2021-08-18
 Oud: 2,2 jaar
 Inbreeding: 10,96%
 Geb. Status: 2

OEL: LP OR

JN 190009
SKAAPVLEI RAM JN190009

Querslag: Vaar Moer
 DNS
 Geneties

JN 180005
SKAAPVLEI EWE JN180005
M: 242 (LP 24) (LP 10) (LP 10)
Lambd: 3 (Lambd: 3) (Lambd: 3)

T 180036
28ROERS RAM T180036

JN 170002
SKAAPVLEI OOI JN 170002
M: 311 (LP 31) (LP 10)
Lambd: 1 (Lambd: 2) (Lambd: 2)

JN 160022
SKAAPVLEI RAM JN 160022

JN 160036
SKAAPVLEI OOI JN 160036
M: 217 (LP 21) (LP 10)
Lambd: 1 (Lambd: 1) (Lambd: 1)

LEEUWOP RAM JN 160025
28ROERS OOI T 160324
M: 308 (LP 30) (LP 10)
Lambd: 2 (Lambd: 2) (Lambd: 2)

SKAAPVLEI RAM JN20021
SKAAPVLEI EWE JN20025
M: 211 (LP 21) (LP 10)
Lambd: 1 (Lambd: 1) (Lambd: 1)

WELPIC RAM JN140023
SKAAPVLEI EWE JN20011
M: 213 (LP 21) (LP 10)
Lambd: 1 (Lambd: 1) (Lambd: 1)

WELPIC RAM JN140023
SKAAPVLEI EWE JN20005
M: 201 (LP 20) (LP 10)
Lambd: 1 (Lambd: 1) (Lambd: 1)

Groei			Reproduksie			
Sgn. Dr.	Sgn. Mac.	Na. Sgn.	GLS	TWW	OEL	LP
83	104	84	86	86	95	119
5%	44%	6%	3%	3%	28%	23%

LOGIX
EBV Analyse 2023-10-05

Logix Meriete Indeks: **86**
 Groei Indeks: **89**
 Reproduksi Indeks: **91**

VERKOPER OPMERKINGS:

LOT NR 106				
Verkoper	Beskrywing	Aantal	Koper	Prys
Thornpark Dormers	Dormer Ooi Dragtig SP	1		

*SPR190172
 *3-3.5 MAANDE DRAGTIG MET TWEELING
 *DRAGTIG VAN JB210161 (SHANANA)
 *INENTINGS / DOSSEERINGS : MULTIVAX P, BLOUTONG



S.P. RAUBENHEIMER
Coolhouse, Eastern Cape
sandra.raubenheimer@abom.co.za

SPR 190172
THORN PARK EWE SPR190172

Fems Book: SP
 Birth date: 2019-08-30
 Age: 4.1 years
 Inbreeding: 10,07%
 Birth Stat: 2

AFL: LP ER
 24.4m 405d 102

Lambd: 2
 Lambd: 2
 Wered: 2

SPR 170024
THORN PARK RAM SPR 170024

Parentage: Sire Dam
 DNA
 Genomic

SPR 160083
THORN PARK OOI SPR 160083
M: 242 (LP 25) (LP 10)
Lambd: 3 (Lambd: 3) (Lambd: 3)

SPR 140158
THORN PARK RAM SPR 140158

SPR 140164
THORN PARK OOI SPR 140164
M: 218 (LP 21) (LP 10)
Lambd: 1 (Lambd: 1) (Lambd: 1)

DZ 130284
DROEVER RAM DZ130284

SPR 130026
THORN PARK OOI SPR 130026
M: 218 (LP 21) (LP 10)
Lambd: 1 (Lambd: 1) (Lambd: 1)

THORN PARK RAM SPR 10009
THORN PARK OOI SPR 12006
M: 214 (LP 21) (LP 10)
Lambd: 1 (Lambd: 1) (Lambd: 1)

BROEVER RAM DZ 10027
THORN PARK OOI SPR 130035
M: 218 (LP 21) (LP 10)
Lambd: 2 (Lambd: 2) (Lambd: 2)

DROEVER RAM DZ 10013
DROEVER OOI DZ 10011
M: 214 (LP 21) (LP 10)
Lambd: 1 (Lambd: 1) (Lambd: 1)

THORN PARK RAM SPR 10044
HEIKLOOF OOI HSB 080027
M: 211 (LP 21) (LP 10)
Lambd: 1 (Lambd: 1) (Lambd: 1)

Growth			Reproduction			
Wn. Dr.	Wn. Mac.	Post. Wn.	NW	TWW	AFL	LP
89	85	87	104	104	101	101
2%	9%	3%	4%	4%	4%	3%

LOGIX
EBV Analyse 2023-10-05

Logix Merit Indeks: **91**
 Growth Indeks: **86**
 Reproduction Indeks: **95**

SELLER REMARKS: 6-8 Weke dragtig met 'n tweeling van JB21-161 (Sha Na Na), Multivax P, Bloutong

LOT NR 108				
Verkoper	Beskrywing	Aantal	Koper	Prys
Thornpark Dormers	Dormer Ooi Dragtig SP	1		

*SPR180012
 *3-3.5 MAANDE DRAGTIG MET EENLING
 *DRAGTIG VAN JB210161 (SHANANA)
 *INENTINGS / DOSSEERINGS : MULTIVAX P, BLOUTONG



S.P. RAUBENHEIMER
Coolhouse, Eastern Cape
sandra.raubenheimer@abom.co.za

SPR 180012
THORN PARK EWE SPR180012

Fems Book: SP
 Birth date: 2018-04-25
 Age: 5.5 years
 Inbreeding: 4,11%
 Birth Stat: 2

AFL: LP ER
 28.2m 394d 95

Lambd: 3
 Lambd: 4
 Wered: 3

T 160020
28ROERS RAM T 160020

Percentage: Sire Dam
 DNA
 Genomic

SPR 130088
THORN PARK OOI SPR 130088
M: 214 (LP 21) (LP 10)
Lambd: 2 (Lambd: 2) (Lambd: 2)

JB 130074
JOHANNI RAM JB 130074

T 130014
28ROERS OOI T 130014
M: 213 (LP 21) (LP 10)
Lambd: 1 (Lambd: 1) (Lambd: 1)

ASJ 090316
TOP 3 RAM ASJ 090316

SPR 100062
THORN PARK OOI SPR 100062
M: 214 (LP 21) (LP 10)
Lambd: 1 (Lambd: 1) (Lambd: 1)

JOHANNI EWE JB 100025
M: 211 (LP 21) (LP 10)
Lambd: 1 (Lambd: 1) (Lambd: 1)

28ROERS RAM T 100073
28ROERS OOI T 090066
M: 213 (LP 21) (LP 10)
Lambd: 1 (Lambd: 1) (Lambd: 1)

TOP 3 RAM ASJ 070028
JOR OOI JOR040001
M: 208 (LP 20) (LP 10)
Lambd: 1 (Lambd: 1) (Lambd: 1)

HERSTOERINGSRAM RAM ASJ 070049
TOP 3 OOI ASJ070049
M: 204 (LP 20) (LP 10)
Lambd: 1 (Lambd: 1) (Lambd: 1)

Growth			Reproduction			
Wn. Dr.	Wn. Mac.	Post. Wn.	NW	TWW	AFL	LP
104	74	102	100	100	98	111
6%	6%	4%	5%	5%	4%	4%

LOGIX
EBV Analyse 2023-10-05

Logix Merit Indeks: **96**
 Growth Indeks: **94**
 Reproduction Indeks: **88**

SELLER REMARKS: 6-8 Weke dragtig met 'n tweeling van JB21-161 (Sha Na Na), Multivax P, Bloutong

LOT NR 109				
Verkoper	Beskrywing	Aantal	Koper	Prys
Thornpark Dormers	Dormer Ooi Dragtig SP	1		

*SPR180253

*3-3.5 MAANDE DRAGTIG MET EENLING

*DRAGTIG VAN JB210161 (SHANANA)

*INENTINGS / DOSSEERINGS : MULTIVAX P, BLOUTONG



S.P. RAUBENHEIMER
Cookhouse, Edgars Cape
sara@raubenh.com | @sara.co.za

SPR 180253
THORN PARK EWE SPR180253

Kuddeboek: SP
Birth date: 2018-09-13
Age: 5.1 years
In teeflig: 9.25%
Birth Sex: 1

AFL: EP: 19.8m 370d 119

Lamb: 3
Lamb: 4
Waaier: 3

DZ 130284
DORRIVER RAM DZ130284

DZ 110115
DORRIVER RAM DZ 110115

DZ 110091
DORRIVER OOI DZ 110091

DZ 120227
DORRIVER RAM DZ 120227

SPR 150088
THORN PARK OOI SPR 150088

SPR 140101
THORN PARK OOI SPR 140101

DORRIVER OOI DZ 070813
DORRIVER OOI DZ 060255
DORRIVER RAM DZ 050242
DORRIVER OOI DZ 040293
DORRIVER RAM DZ 101415
DORRIVER OOI DZ 040803
THORN PARK RAM SPR 100619
DORRIVER OOI HSK 070223

Growth			Reproduction			
Wt. Dir.	Woon Hct.	Post. Wt.	NOV	TYW	AFL	EP
97	100	95	106	106	106	109
60%	67%	34%	53%	53%	49%	41%

LOGIX
EBV Analyse 21Q3-10-05

Logix Merit Index **105**
Growth Index **100**
Reproduction Index **110**

SELLER REMARKS: 6-B Waaie dragtigmet 'n eenling van JB21-161 (Sha Na Na), Multivax P, Bloutong

LOT NR 110				
Verkoper	Beskrywing	Aantal	Koper	Prys
Thornpark Dormers	Dormer Ooi Dragtig SP	1		

*SPR200146

*3-3.5 MAANDE DRAGTIG MET TWEELING

*DRAGTIG VAN JB210161 (SHANANA)

*INENTINGS / DOSSEERINGS : MULTIVAX P, BLOUTONG



S.P. RAUBENHEIMER
Cookhouse, Edgars Cape
sara@raubenh.com | @sara.co.za

SPR 200146
THORN PARK EWE SPR200146

Kuddeboek: SP
Geb. datum: 2020-09-01
Oud: 3.1 jaar
In teeflig: 6.74%
Geb. Status: 2

OEL: EP: 25.7m - 99

Gelom: 1
Lamb: 1
Geprent: 1

T 160020
ZBRVRS RAM T 160020

SPR 160107
THORN PARK OOI SPR 160107

DZ 120229
DORRIVER RAM DZ 120229

SPR 120162
THORN PARK OOI SPR 120162

SPR 190044
THORN PARK RAM SPR190044

SPR 160069
THORN PARK EWE SPR160069

ZBRVRS OOI T 130014
DORRIVER RAM DZ130284
THORN PARK OOI SPR130050
DORRIVER RAM DZ 101415
DORRIVER OOI DZ 040307
TOP 3 RAM AS040316
THORN PARK OOI SPR 100619

Groeï			Reproduksie			
Spn. Dir.	Spn. Hct.	Na-Spn.	G.S.	TYW	OEL	EP
96	97	96	113	113	98	104
60%	54%	37%	40%	40%	32%	30%

LOGIX
EBV Analyse 2023-10-05

Logix Merite Index **105**
Groeï Indeks **98**
Reproduksie Indeks **111**

VERKOPER OPMERKINGS: 6-B Waaie dragtig met 'n tweeling van JB21-161 (Sha Na Na), Multivax P, Bloutong

LOT NR 111				
Verkoper	Beskrywing	Aantal	Koper	Prys
Thornpark Dormers	Dormer Ooi Dragtig SP	1		

*SPR200128

*3-3.5 MAANDE DRAGTIG MET EENLING

*DRAGTIG VAN JB210161 (SHANANA)

*INENTINGS / DOSSEERINGS : MULTIVAX P, BLOUTONG



S.P. RAUBENHEIMER
Cookhouse, Edgars Cape
sara@raubenh.com | @sara.co.za

SPR 200128
THORN PARK EWE SPR200128

Kuddeboek: SP
Geb. datum: 2020-08-30
Oud: 3.1 jaar
In teeflig: 17.88%
Geb. Status: 2

OEL: EP: 26m - 99

Gelom: 1
Lamb: 1
Geprent: 1

DZ 130284
DORRIVER RAM DZ130284

SPR 140092
THORN PARK OOI SPR 140092

DZ 130284
DORRIVER RAM DZ130284

SPR 140167
THORN PARK OOI SPR140167

SPR 170129
THORN PARK RAM SPR 170129

SPR 160048
THORN PARK EWE SPR160048

DORRIVER RAM DZ 101415
DORRIVER OOI DZ 10091
THORN PARK RAM SPR 100619
DORRIVER RAM DZ 101415
DORRIVER OOI DZ 10091
DORRIVER RAM DZ 03027

Groeï			Reproduksie			
Spn. Dir.	Spn. Hct.	Na-Spn.	G.S.	TYW	OEL	EP
97	99	95	109	109	101	109
63%	57%	34%	44%	44%	40%	30%

LOGIX
EBV Analyse 2023-10-05

Logix Merite Indeks **106**
Groeï Indeks **100**
Reproduksie Indeks **111**

VERKOPER OPMERKINGS: 6-B Waaie dragtig met 'n eenling van JB21-161 (Sha Na Na), Multivax P, Bloutong

LOT NR 112				
Verkoper	Beskrywing	Aantal	Koper	Prys
Thornpark Dormers	Dormer Ooi Dragtig SP	1		

*SPR190333

*3-3.5 MAANDE DRAGTIG MET EENLING

*DRAGTIG VAN JB210161 (SHANANA)

*INENTINGS / DOSSEERINGS : MULTIVAX P, BLOUTONG



S.P. RAUBENHEIMER
Coëwoude, Edwert 1 Cebu
sara@raubenhier.nl @sara-rau

SPR 190333
THORN PARK EWE SPR190333

Ras: SP
Geb. dat: 2019-09-17
Oud: 4.1 jaar
Integ: 11.89%
Gen. Statu: 2
CEL: LP GP
ZS-Bm: 402M III
Galum: 2
Lentema: 3
Geupen: 3

SPR 170129
THORN PARK RAM SPR 170129
Duenskap / Vaar Noer:
DNS:
Geneties:

SPR 170109
THORN PARK OOI SPR 170109
US: A1 (LP 54) GP: K1
Coem 2 (Lentema 4) / Coem 3

DZ 130284
DROEVIER RAM DZ 130284
US: A1 (LP 54) GP: K1
Coem 2 (Lentema 3) / Coem 3

SPR 160092
THORN PARK OOI SPR 160092
US: A1 (LP 54) GP: K1
Coem 2 (Lentema 3) / Coem 3

SPR 160066
THORN PARK OOI SPR 160066
US: A1 (LP 54) GP: K1
Coem 2 (Lentema 3) / Coem 3

SPR 160037
THORN PARK OOI SPR 160037
US: A1 (LP 54) GP: K1
Coem 2 (Lentema 3) / Coem 3

Groot			Reproduksie			
Spn. Dr.	Spn. Mac.	Na. Spn.	GLS	T/W	CEL	LP
88	106	91	108	108	101	120
67%	60%	22%	42%	47%	40%	31%

LOGIX
EBV Analyse 2023-10-05

Logix Meriete Indeks **103**
Groot Indeks **95**
Reproduksie Indeks **114**

VERKOPER OPMERKINGS: 6-8 Weke dragtig met 'n eenling van JB21-161 (Sha Na Na), Multivax P, Bloutong

LOT NR 115				
Verkoper	Beskrywing	Aantal	Koper	Prys
Thornpark Dormers	Dormer Ooi Dragtig SP	1		

*SPR210240

*3-3.5 MAANDE DRAGTIG MET EENLING

*DRAGTIG VAN JB210161 (SHANANA)

*INENTINGS / DOSSEERINGS : MULTIVAX P, BLOUTONG



S.P. RAUBENHEIMER
Coëwoude, Edwert 1 Cebu
sara@raubenhier.nl @sara-rau

SPR 210240
THORN PARK OOI SPR 210240

Ras: SP
Beri dat: 2021-09-10
Age: 2.1 years
Inbreeding: 4.45%
Birth Stat: 2
APL: LP EP

SPR 180015
SMH RAM SMH 180015
Percentage / Size / Dam:
DNA:
Geneties:

SPR 160006
THORN PARK OOI SPR 160006
US: A1 (LP 47) GP: K1
Lentema 2 (Lentema 3) / Lentema 3

JB 160040
JOHANNI RAM JB 160040
US: A1 (LP 47) GP: K1
Lentema 2 (Lentema 3) / Lentema 3

JB 120166
JOHANNI OOI JB 120166
US: A1 (LP 47) GP: K1
Lentema 2 (Lentema 3) / Lentema 3

DZ 130284
DROEVIER RAM DZ 130284
US: A1 (LP 54) GP: K1
Coem 2 (Lentema 3) / Coem 3

SPR 120044
HEIKLOOF RAM HSB 120044
US: A1 (LP 47) GP: K1
Lentema 2 (Lentema 3) / Lentema 3

Growth			Reproduction			
Wt. Dr.	Wean Mac.	Post. Wt.	NEW	T/W	APL	LP
93	112	96	91	91	95	96
62%	37%	34%	39%	37%	36%	21%

LOGIX
EBV Analyse 2023-10-05

Logix Merite Indeks **97**
Growth Indeks **102**
Reproduksie Indeks **100**

SELLER REMARKS: 6-8 Weke dragtig met 'n eenling van JB21-161 (Sha Na Na), Multivax P, Bloutong

LOT NR 116				
Verkoper	Beskrywing	Aantal	Koper	Prys
Thornpark Dormers	Dormer Ooi Dragtig SP	1		

*SPR210215

*3-3.5 MAANDE DRAGTIG MET EENLING

*DRAGTIG VAN JB210161 (SHANANA)

*INENTINGS / DOSSEERINGS : MULTIVAX P, BLOUTONG



S.P. RAUBENHEIMER
Coëwoude, Edwert 1 Cebu
sara@raubenhier.nl @sara-rau

SPR 210215
THORN PARK OOI SPR 210215

Ras: SP
Beri dat: 2021-09-06
Age: 2.1 years
Inbreeding: 4.14%
Birth Stat: 1
APL: LP EP

JS 180001
KIND RAM JS 180001
Percentage / Size / Dam:
DNA:
Geneties:

SPR 170052
THORN PARK OOI SPR 170052
US: A1 (LP 54) GP: K1
Lentema 4 (Lentema 4) / Lentema 4

JS 160855
KIND RAM JS 160855
US: A1 (LP 54) GP: K1
Lentema 4 (Lentema 4) / Lentema 4

JS 150312
KIND OOI JS 150312
US: A1 (LP 54) GP: K1
Lentema 4 (Lentema 4) / Lentema 4

SPR 130060
THORN PARK RAM SPR 130060
US: A1 (LP 54) GP: K1
Lentema 4 (Lentema 4) / Lentema 4

SPR 120089
THORN PARK OOI SPR 120089
US: A1 (LP 54) GP: K1
Lentema 4 (Lentema 4) / Lentema 4

Growth			Reproduction			
Wt. Dr.	Wean Mac.	Post. Wt.	NEW	T/W	APL	LP
100	80	101	94	94	111	90
67%	32%	47%	41%	41%	38%	30%

LOGIX
EBV Analyse 2023-10-05

Logix Merite Indeks **95**
Growth Indeks **94**
Reproduksie Indeks **90**

SELLER REMARKS: 6-8 Weke dragtig met 'n eenling van JB21-161 (Sha Na Na), Multivax P, Bloutong

LOT NR 117				
Verkoper	Beskrywing	Aantal	Koper	Prys
Thornpark Dormers	Dormer Ooi Dragtig SP	1		

*SPR210086

*3-3.5 MAANDE DRAGTIG MET TWEELING

*DRAGTIG VAN JB210161 (SHANANA)

*INENTINGS / DOSSEERINGS : MULTIVAX P, BLOUTONG



S.P. RAUBENHEIMER
Coëffhous, Edson's Caba
sara@raubenheime.co.za

SPR 210086
THORN PARK OOI SPR 210086

Huid Beek SP
Geb. datum 2021-08-31
Oud. 2,1 years
Inbreeding 4,25%
Geb. Soort 1
CEL LP EV

Parentage Sire Dam
DNA
Genomics

SPR 170186
THORN PARK OOI SPR 170186
CEL 24 (LP 24) OF 12
Geb. 2 (Lamb 2) (Lamb 1) (Lamb 1)

JS 160855
NAND RAM JS 160855
KINKO OOI JS 140421
KINKO RAM JS 130636
KINKO OOI JS 130569
DROEVRER RAM DZ 10015
DROEVRER OOI DZ 10091
TOP 3 RAM ASJ090316
TOP 3 OOI ASJ070049

Growth			Reproduction			
Wt. Dir.	Wan. Mac.	Post. Wt.	NW	TW	AFI	LP
107	90	107	98	98	108	100
67%	52%	43%	4%	4%	38%	30%

LOGIX
EBV Analyse 2023-10-05

Logix Meriete Indeks **105**
Groeie Indeks **105**
Reproduksie Indeks **99**

SELLER REMARKS: 6-8 Weke dragtig met 'n tweeling van JB21-161 (Sha Na Na), Multivax P, Bloutong

LOT NR 118				
Verkoper	Beskrywing	Aantal	Koper	Prys
Thornpark Dormers	Dormer Ooi Dragtig SP	1		

*SPR210138

*3-3.5 MAANDE DRAGTIG MET TWEELING

*DRAGTIG VAN JB210161 (SHANANA)

*INENTINGS / DOSSEERINGS : MULTIVAX P, BLOUTONG



S.P. RAUBENHEIMER
Coëffhous, Edson's Caba
sara@raubenheime.co.za

SPR 210138
THORN PARK OOI SPR 210138

Kuddebeek SP
Geb. datum 2021-08-31
Oud. 2,1 jaar
Inbreeding 4,63%
Geb. Soort 2
CEL LP GP

Ouerskap / Voor Noer
DNA
Genomics

SPR 170210
THORN PARK OOI SPR 170210
CEL 24 (LP 24) OF 12
Geb. 2 (Lamb 2) (Lamb 1) (Lamb 1)

JB 160040
JOHANN RAM JB 14074
JOHANN OOI JB 130608
JOHANN RAM JB 130126
JOHANN OOI JB 130064
DROEVRER RAM DZ 10015
DROEVRER OOI DZ 10091
THORN PARK RAM SPR 10004
THORN PARK OOI SPR 12018

Groeie			Reproduksie			
Spn. Dir.	Spn. Mac.	Na. Spn.	GLS	TW	CEL	LP
106	117	107	92	92	96	92
67%	55%	34%	38%	38%	35%	28%

LOGIX
EBV Analyse 2023-10-05

Logix Meriete Indeks **109**
Groeie Indeks **117**
Reproduksie Indeks **107**

VERKOPER OPMERKINGS: Dragtig met 'n tweeling van JB21-161 (Sha Na Na), Multivax P, Bloutong

LOT NR 119				
Verkoper	Beskrywing	Aantal	Koper	Prys
Thornpark Dormers	Dormer Ooi Dragtig SP	1		

*SPR210008

*3-3.5 MAANDE DRAGTIG MET EENLING

*DRAGTIG VAN JB210161 (SHANANA)

*INENTINGS / DOSSEERINGS : MULTIVAX P, BLOUTONG



S.P. RAUBENHEIMER
Coëffhous, Edson's Caba
sara@raubenheime.co.za

SPR 210008
THORN PARK OOI SPR 210008

Kuddebeek SP
Geb. datum 2021-05-27
Oud. 2,4 jaar
Inbreeding 4,64%
Geb. Soort 3
CEL LP GP

Ouerskap / Voor Noer
DNA
Genomics

SPR 160163
THORN PARK OOI SPR 160163
CEL 24 (LP 24) OF 12
Geb. 2 (Lamb 2) (Lamb 1) (Lamb 1)

JB 160040
JOHANN RAM JB 14074
JOHANN OOI JB 130608
JOHANN RAM JB 130126
JOHANN OOI JB 130064
EYERSAR RAM EN 090004
HEKLOOF OOI HSB 090007
HEKLOOF RAM HSB 10018
TOP 3 OOI ASJ 080130

Groeie			Reproduksie			
Spn. Dir.	Spn. Mac.	Na. Spn.	GLS	TW	CEL	LP
102	110	101	94	94	97	93
67%	52%	33%	40%	40%	35%	28%

LOGIX
EBV Analyse 2023-10-05

Logix Meriete Indeks **104**
Groeie Indeks **110**
Reproduksie Indeks **103**

VERKOPER OPMERKINGS: Dragtig met 'n eenling van JB21-161 (Sha Na Na), Multivax P, Bloutong

LOT NR 120				
Verkoper	Beskrywing	Aantal	Koper	Prys
Thornpark Dormers	Dormer Ooi Dragtig SP	1		

*SPR210099

*3-3.5 MAANDE DRAGTIG MET TWEELING

*DRAGTIG VAN JB210161 (SHANANA)

*INENTINGS / DOSSEERINGS : MULTIVAX P, BLOUTONG



dormer

S.P. RAUBENHEIMER
Coolhouse, Eastern Cape
schmidtd@berthafrica.co.za

SPR 210099
THORN PARK OOI SPR 210099

Ruitermerk	SP
Geb. d.m.	2021-08-31
Oud.	2.1 jaar
Intsig.	4.25%
Geb. Status	2
GEL	LP
OP	

QR Code: 

JS 180001
KIND RAM JS 180001

JS 150312
KIND OOI JS 150312

SPR 170119
THORN PARK RAM SPR 170119

SPR 160203
THORN PARK OOI SPR 160203

JS 160855
KIND RAM JS 160855

JS 140752
KIND RAM JS 140752

JS 140421
KIND OOI JS 140421

JS 130609
KIND RAM JS 130609

JS 130180
KIND OOI JS 130180

THORN PARK RAM SPR 150111

THORN PARK EYE SPR150048

THORN PARK RAM SPR140189

THORN PARK EYE SPR140144

Groei			Reproduksie			
Spn. Dn.	Spn. Hae.	Na. Spn.	GLS	TYW	CEL	LP
112	72	108	107	107	110	96
60%	90%	44%	36%	38%	33%	26%

LOGIX
EBV Analyse 2023-10-05

Logix Meriete Indeks	106
Groei Indeks	101
Reproduksie Indeks	97

VERKOPER OPMERKINGS: Dragtig met 'n tweeling van JB21-161 (Sha Na Na)
Multivax P, Bloutong

LOT NR 121				
Verkoper	Beskrywing	Aantal	Koper	Prys
Prospect Dormers	Dormer Ooi Kommerisieël	5		

*Dragtig bevestig

*Entings: Multivax P+, Cydectin LA, Multimin

LOT NR 122				
Verkoper	Beskrywing	Aantal	Koper	Prys
Prospect Dormers	Dormer Ooi Kommerisieël	5		

*Dragtig bevestig

*Entings: Multivax P+, Cydectin LA, Multimin

LOT NR 123				
Verkoper	Beskrywing	Aantal	Koper	Prys
Prospect Dormers	Dormer Ooi Kommerisieël	5		

*Dragtig bevestig

*Entings: Multivax P+, Cydectin LA, Multimin

LOT 124				
Verkoper	Beskrywing	Aantal	Koper	Prys
Prospect Dormers	Dormer Ooi Kommerisieël	5		

*Oop wissel ootjies, reg vir ram

*Entings: Entings: Multivax P+, Cydectin LA, Multimin

LOT NR 125				
Verkoper	Beskrywing	Aantal	Koper	Prys
Prospect Dormers	Dormer Ooi Kommerisieël	5		

*Oop wissel ootjies, reg vir ram

*Entings: Entings: Multivax P+, Cydectin LA, Multimin

LOT NR 126				
Verkoper	Beskrywing	Aantal	Koper	Prys
Prospect Dormers	Dormer Ooi Kommerseel	5		

*Oop wissel ooitjies, reg vir ram

*Entings: Entings: Multivax P+, Cydectin LA, Multimin

LOT NR 127				
Verkoper	Beskrywing	Aantal	Koper	Prys
Prospect Dormers	Dormer Ooi Kommerseel	5		

*Oop wissel ooitjies, reg vir ram

*Entings: Entings: Multivax P+, Cydectin LA, Multimin

LOT NR 128				
Verkoper	Beskrywing	Aantal	Koper	Prys
Prospect Dormers	Dormer Ooi Kommerseel	5		

*Oop wissel ooitjies, reg vir ram

*Entings: Entings: Multivax P+, Cydectin LA, Multimin

LOT NR 129				
Verkoper	Beskrywing	Aantal	Koper	Prys
FB Damaras	Damara Ooi nie dragtig	2		

*INENTINGS / DOSSEERINGS : MULTIVAX P

*INENTINGS / DOSSEERINGS : BLOEDNIER, PASTEURRELA

*3A, 5A

LOT NR 130				
Verkoper	Beskrywing	Aantal	Koper	Prys
FB Damaras	Damara Ooi Dragtig kommersieel	2		

*INENTINGS / DOSSEERINGS : MULTIVAX P

*INENTINGS / DOSSEERINGS : BLOEDNIER, PASTEURRELA

*1A, 2B

LOT NR 130A				
Verkoper	Beskrywing	Aantal	Koper	Prys
FB Damaras	Damara Ooi Dragtig kommersieel	2		

*INENTINGS / DOSSEERINGS : MULTIVAX P

*INENTINGS / DOSSEERINGS : BLOEDNIER, PASTEURRELA

*4B, 6B

LOT NR 130B				
Verkoper	Beskrywing	Aantal	Koper	Prys
FB Damaras	Damara Ooi Dragtig kommersieel	2		

*INENTINGS / DOSSEERINGS : MULTIVAX P

*INENTINGS / DOSSEERINGS : BLOEDNIER, PASTEURRELA

*7A, 8B

LOT NR 130C				
Verkoper	Beskrywing	Aantal	Koper	Prys
FB Damaras	Damara Ooi Dragtig kommersieel	2		

*INENTINGS / DOSSEERINGS : MULTIVAX P

*INENTINGS / DOSSEERINGS : BLOEDNIER, PASTEURRELA

*9A, 10B

LOT NR 131				
Verkoper	Beskrywing	Aantal	Koper	Prys
Zandraai Veldmasters	Veldmaster ooi nie-dragtig kommersieel	2		

*INENTINGS / DOSSERINGS : BLOEDNIER, PASTEURRELA
*180, 183

LOT NR 132				
Verkoper	Beskrywing	Aantal	Koper	Prys
Zandraai Veldmasters	Veldmaster ooi nie-dragtig kommersieel	2		

*INENTINGS / DOSSERINGS : BLOEDNIER, PASTEURRELA
*145, 155

LOT NR 133				
Verkoper	Beskrywing	Aantal	Koper	Prys
Zandraai Veldmasters	Veldmaster Ooi dragtig Kommersieel	2		

*INENTINGS / DOSSERINGS : BLOEDNIER, PASTEURRELA
*157, 191

LOT NR 134				
Verkoper	Beskrywing	Aantal	Koper	Prys
Zandraai Veldmasters	Veldmaster Ooi dragtig Kommersieel	2		

*INENTINGS / DOSSERINGS : BLOEDNIER, PASTEURRELA
*163, 189

LOT NR 135				
Verkoper	Beskrywing	Aantal	Koper	Prys
Zandraai Veldmasters	Veldmaster Ooi dragtig Kommersieel	2		

*INENTINGS / DOSSERINGS : BLOEDNIER, PASTEURRELA
*148, 166

LOT NR 136				
Verkoper	Beskrywing	Aantal	Koper	Prys
Zandraai Veldmasters	Veldmaster Ooi dragtig Kommersieel	2		

*INENTINGS / DOSSERINGS : BLOEDNIER, PASTEURRELA
*172, 176

BKB



Bees / Cattle

OUTENIQUA INTERRASVEILING

20 OKTOBER 2023

LOT NR 1				
Verkoper	Beskrywing	Aantal	Koper	Prys
Knoetzekamma Limousines	Limousin Bul SP	1		

*JJ20 30

*INENTINGS / DOSSERINGS : RB51, PILLIGUARD, SUPAVAX, LUMPY SKIN, CATTLE MASTER

*HAS LENGTH, DEPTH & WIDTH. HIS FULL BROTHER IS ONE OF OUR CURRENT STUD BULLS, JJ1923. HE HAS EXCELLENT DAM WITH ICP OF 381 DAYS AND A THICK LA RHONE REBEL SON.

Limousin Animal Details KNOETZEKAMMA KONING

Identification: JJ2030
Sex: Male
Birth Date: 21/12/2020
Computer Number: 8797217117
HerdBook: SP Inspection Date: 11/08/22
Status: Active
Registration Status: Registered
Breeder: [J.J. WATSON](#)
Current Owner: [J.J. WATSON](#)
By AI: Sire Verified #3538U019
Progeny: None
EBV Graph: [\[View\]](#)

— [WILZAK 02102 ZIP MAN](#)

— [LA RHONE HITMAN](#)

— [XCELBO TANGOLINE](#)

— Sire: [LA RHONE REBEL](#)

— [DEVLAN LENGTH 04 104](#)

— [DEVLAN LONG MUSCLE 08 112](#)

— [DEVLAN 00 140](#)

Animal: [KNOETZEKAMMA KONING](#)

— [JUNIOR](#)

— [KNOETZEKAMMA JUDGE](#)

— [MARLIBA MELANI](#)

— Dam: [KNOETZEKAMMA 0747 POWER GIRL](#)

— [WANITA POWER PLUS 2](#)

— [KNOETZEKAMMA KNOETZE POWER GIRL](#)

— [JACRE FUNNY VG9448](#)

September 2023 Southern Limousin BREEDPLAN																	
	Calving Ease DIR (%)	Calving Ease DTRS (%)	Gestation Length (days)	Birth Wt. (kg)	200 Day Wt (kg)	400 Day Wt (kg)	600 Day Wt (kg)	Mat Cow Wt (kg)	Milk (kg)	Scrotal Size (cm)	Carcase Wt (kg)	Eye Muscle Area (sq cm)	Rib Fat (mm)	Rump Fat (mm)	Retail Beef Yield (%)	IMF (%)	Docility (%)
EBV	-5.4	-0.3	+1.3	+3.8	+22	+34	+45	+40	+5	+1.0	+20	-0.5	+0.2	-0.2	+0.3	+0.1	-
Accuracy	38%	27%	45%	68%	60%	59%	62%	52%	48%	46%	44%	28%	33%	33%	30%	28%	-
Breed Avg. EBVs for 2021 Born Calves Click for Percentiles																	
EBV	+0.5	+0.8	-2.1	+1.7	+21	+35	+49	+48	+7	+1.1	+31	+1.8	+0.0	-0.1	+0.8	+0.0	+42
Traits Analysed: BWT,200WT,SS																	

LOT NR 2				
Verkoper	Beskrywing	Aantal	Koper	Prys
Knoetzekamma Limousines	Limousin Bul SP	1		

*JJ21 01

*INENTINGS / DOSSERINGS : RB51, PILLIGUARD, SUPAVAX, LUMPY SKIN, CATTLE MASTER

*HE IS A THICK LA RHONE REBEL SON WITH AN EXCELLENT DAM. HE IS A BROTHER TO JJ1819 WHO IS ALSO OFFERED AT THE AUCTION.

Limousin Animal Details KNOETZEKAMMA LEXINGTON

Identification: JJ211
Sex: Male
Birth Date: 18/01/2021
Computer Number: 8797218768
HerdBook: SP **Inspection Date:** 11/08/22
Status: Active
Registration Status: Registered
Breeder: [J.J. WATSON](#)
Current Owner: [J.J. WATSON](#)
By AI: Sire Verified #12315U001
Progeny: None
EBV Graph: [\[View\]](#)

— [WILZAK 02102 ZIP MAN](#)
 — [LA RHONE HITMAN](#)
 — [XCELBO TANGOLINE](#)
 — **Sire:** [LA RHONE REBEL](#)
 — [DEVLAN LENGTH 04 104](#)
 — [DEVLAN LONG MUSCLE 08 112](#)
 — [DEVLAN 00 140](#)
Animal: [KNOETZEKAMMA LEXINGTON](#)
 — [BON CHANCE GENOEG 80](#)
 — [KNOETZEKAMMA AG-GENEE](#)
 — [KNOETZEKAMMA KNOETZE POWER GIRL](#)
 — **Dam:** [KNOETZEKAMMA ANGEL DUCH](#)
 — [COCO DUCHSON](#)
 — [COCO DUCH RADOON 19](#)
 — [COCO TARVIS RACoon](#)

September 2023 Southern Limousin BREEDPLAN

	Calving Ease DIR (%)	Calving Ease DTRS (%)	Gestation Length (days)	Birth Wt. (kg)	200 Day Wt (kg)	400 Day Wt (kg)	600 Day Wt (kg)	Mat Cow Wt (kg)	Milk (kg)	Scrotal Size (cm)	Carcass Wt (kg)	Eye Muscle Area (sq cm)	Rib Fat (mm)	Rump Fat (mm)	Retail Beef Yield (%)	IMF (%)	Docility (%)
EBV	-0.7	+0.4	+1.3	+2.2	+16	+22	+31	+22	+5	+0.9	+18	+0.4	+0.2	-0.1	+0.4	-0.1	-
Accuracy	38%	27%	42%	59%	55%	55%	57%	48%	47%	44%	43%	28%	34%	33%	31%	28%	-
Breed Avg. EBVs for 2021 Born Calves Click for Percentiles																	
EBV	+0.5	+0.8	-2.1	+1.7	+21	+35	+49	+48	+7	+1.1	+31	+1.8	+0.0	-0.1	+0.8	+0.0	+42

Traits Analysed: BWT,200WT,600WT(x2),SS

LOT NR 3				
Verkoper	Beskrywing	Aantal	Koper	Prys
Steynberg Boerdery Trust	Bonsmara Bul SP	1		

*SBT20 001

Bonsmara SA Cattle Breeders' Society
 Compiled by the South African Stud Book and Livestock Improvement Association
 All Pedigree and Performance Data has been certified in context.

BULLS

STEYNBERG BOERDERY SBT 200001 2020-08-01 SP Percentage: Sire Dam DNA <input checked="" type="checkbox"/> Genomic <input checked="" type="checkbox"/>	HBT 170037 P SBT 170047 2020-08-01 FVG 170037, 100 07/24	TOR 110020 TOR 080133 2019-08-01 40% (170037) 60%	LDW 070041 TOR 080133 2019-08-01 40% (170037) 60%	Calving Ease Value 99	Weaner Calf Value 99	Fertility Value 103	Maintenance Value 98	Cow Value 100	Growth Value 99	Carcass Value 102																																																																								
		HBT 120004 P HBT 090080 2019-08-01 FVG 120004, 100 07/24	MCU 070007 P HBT 090080 2019-08-01 FVG 120004, 100 07/24	<table border="1"> <tr> <th colspan="3">Calf and Mother</th> <th colspan="4">Fertility</th> <th colspan="3">Post-Wean Growth</th> <th colspan="3">Frame</th> <th colspan="3">Carcass</th> </tr> <tr> <th>Birth Dn</th> <th>Wean Dn</th> <th>Wean Stat</th> <th>Scr Circ</th> <th>Hartr Fert</th> <th>Calf Fert</th> <th>Longev</th> <th>Post Wean</th> <th>ADG</th> <th>FCR</th> <th>Mature Weight</th> <th>Height</th> <th>Length</th> <th>BMA</th> <th>Rc</th> <th>Mar</th> </tr> <tr> <td>97</td> <td>102</td> <td>97</td> <td>110</td> <td>104</td> <td>110</td> <td>88</td> <td>103</td> <td>97</td> <td>99</td> <td>101</td> <td>106</td> <td>106</td> <td>97</td> <td>102</td> <td>98</td> </tr> </table>		Calf and Mother			Fertility				Post-Wean Growth			Frame			Carcass			Birth Dn	Wean Dn	Wean Stat	Scr Circ	Hartr Fert	Calf Fert	Longev	Post Wean	ADG	FCR	Mature Weight	Height	Length	BMA	Rc	Mar	97	102	97	110	104	110	88	103	97	99	101	106	106	97	102	98	<table border="1"> <tr> <th>Wean Index</th> <th>365D Index</th> <th>540D Index</th> <th>ADG Index</th> <th>FCR Index</th> <th>Scrotum</th> <th>LH</th> </tr> <tr> <td>93</td> <td>104</td> <td>110</td> <td>-</td> <td>-</td> <td>-</td> <td>-</td> </tr> </table>		Wean Index	365D Index	540D Index	ADG Index	FCR Index	Scrotum	LH	93	104	110	-	-	-	-	<table border="1"> <tr> <th colspan="3">Myostatin</th> </tr> <tr> <td>Q204K</td> <td colspan="2">Not Tested</td> </tr> <tr> <td>N182I</td> <td colspan="2">Not Tested</td> </tr> <tr> <td>P94L</td> <td colspan="2">Not Tested</td> </tr> </table>	Myostatin			Q204K	Not Tested		N182I	Not Tested		P94L	Not Tested	
		Calf and Mother			Fertility				Post-Wean Growth			Frame			Carcass																																																																			
		Birth Dn	Wean Dn	Wean Stat	Scr Circ	Hartr Fert	Calf Fert	Longev	Post Wean	ADG	FCR	Mature Weight	Height	Length	BMA	Rc	Mar																																																																	
97	102	97	110	104	110	88	103	97	99	101	106	106	97	102	98																																																																			
Wean Index	365D Index	540D Index	ADG Index	FCR Index	Scrotum	LH																																																																												
93	104	110	-	-	-	-																																																																												
Myostatin																																																																																		
Q204K	Not Tested																																																																																	
N182I	Not Tested																																																																																	
P94L	Not Tested																																																																																	
AT 120217 AT 060026 2019-08-01 FVG 120217, 100 07/24	AT 100033 AT 060026 2019-08-01 FVG 120217, 100 07/24	REMARKS:																																																																																
SBT 120097 SBT 120097 2020-08-01 AT 120217, 100 07/24		LOGIX EBY Analysis: 2023-08-23																																																																																

LOT NR 4				
Verkoper	Beskrywing	Aantal	Koper	Prys
Steynberg Boerdery Trust	Bonsmara Bul SP	1		

*SBT20 003

Bonsmara SA Cattle Breeders' Society
 Compiled by the South African Stud Book and Livestock Improvement Association
 All Pedigree and Performance Data has been certified in context.

BULLS

STEYNBERG BOERDERY SBT 200003 2020-08-01 B Percentage: Sire Dam DNA <input checked="" type="checkbox"/> Genomic <input checked="" type="checkbox"/>	HBT 170037 P SBT 170023 2020-08-01 FVG 170037, 100 07/24	TOR 110020 TOR 080133 2019-08-01 40% (170037) 60%	LDW 070041 TOR 080133 2019-08-01 40% (170037) 60%	Calving Ease Value 119	Weaner Calf Value 95	Fertility Value 97	Maintenance Value 98	Cow Value 98	Growth Value -	Carcass Value 98																																																																								
		HBT 120004 P HBT 090080 2019-08-01 FVG 120004, 100 07/24	MCU 070007 P HBT 090080 2019-08-01 FVG 120004, 100 07/24	<table border="1"> <tr> <th colspan="3">Calf and Mother</th> <th colspan="4">Fertility</th> <th colspan="3">Post-Wean Growth</th> <th colspan="3">Frame</th> <th colspan="3">Carcass</th> </tr> <tr> <th>Birth Dn</th> <th>Wean Dn</th> <th>Wean Stat</th> <th>Scr Circ</th> <th>Hartr Fert</th> <th>Calf Fert</th> <th>Longev</th> <th>Post Wean</th> <th>ADG</th> <th>FCR</th> <th>Mature Weight</th> <th>Height</th> <th>Length</th> <th>BMA</th> <th>Rc</th> <th>Mar</th> </tr> <tr> <td>117</td> <td>92</td> <td>94</td> <td>97</td> <td>103</td> <td>101</td> <td>88</td> <td>92</td> <td>95</td> <td>91</td> <td>100</td> <td>101</td> <td>104</td> <td>94</td> <td>97</td> <td>98</td> </tr> </table>		Calf and Mother			Fertility				Post-Wean Growth			Frame			Carcass			Birth Dn	Wean Dn	Wean Stat	Scr Circ	Hartr Fert	Calf Fert	Longev	Post Wean	ADG	FCR	Mature Weight	Height	Length	BMA	Rc	Mar	117	92	94	97	103	101	88	92	95	91	100	101	104	94	97	98	<table border="1"> <tr> <th>Wean Index</th> <th>365D Index</th> <th>540D Index</th> <th>ADG Index</th> <th>FCR Index</th> <th>Scrotum</th> <th>LH</th> </tr> <tr> <td>96</td> <td>107</td> <td>110</td> <td>-</td> <td>-</td> <td>-</td> <td>-</td> </tr> </table>		Wean Index	365D Index	540D Index	ADG Index	FCR Index	Scrotum	LH	96	107	110	-	-	-	-	<table border="1"> <tr> <th colspan="3">Myostatin</th> </tr> <tr> <td>Q204K</td> <td colspan="2">Not Tested</td> </tr> <tr> <td>N182I</td> <td colspan="2">Not Tested</td> </tr> <tr> <td>P94L</td> <td colspan="2">Not Tested</td> </tr> </table>	Myostatin			Q204K	Not Tested		N182I	Not Tested		P94L	Not Tested	
		Calf and Mother			Fertility				Post-Wean Growth			Frame			Carcass																																																																			
		Birth Dn	Wean Dn	Wean Stat	Scr Circ	Hartr Fert	Calf Fert	Longev	Post Wean	ADG	FCR	Mature Weight	Height	Length	BMA	Rc	Mar																																																																	
117	92	94	97	103	101	88	92	95	91	100	101	104	94	97	98																																																																			
Wean Index	365D Index	540D Index	ADG Index	FCR Index	Scrotum	LH																																																																												
96	107	110	-	-	-	-																																																																												
Myostatin																																																																																		
Q204K	Not Tested																																																																																	
N182I	Not Tested																																																																																	
P94L	Not Tested																																																																																	
MULTIPLE SIRE	SBT 120030 SBT 120030 2020-08-01 AT 120217, 100 07/24	REMARKS:																																																																																
		LOGIX EBY Analysis: 2023-08-23																																																																																

LOT NR 5				
Verkoper	Beskrywing	Aantal	Koper	Prys
Kyksim Simmentalers	Simmentaler Bul SP	1		

*BMB 20 3

*Seun van senior kampioen bul op die Riversdal Skou 2023

OFFICIAL RECORD / AMPTELIKE REKORD <small>Outentiqua Intergrasveiling, 20x10/2023</small>	BOTHASIM SMILEY		BMB203		
	BM BOTHA, POSBUS 10841 GEORGE 6530 TEL:27824402763				SIMMENTALER
	Birth Date: 28/06/2020 DNA: 8641U001, SV		Reg. Status: REG		MALE/MANLIK
	Age: 39 months Herdbook: SP Horn: Polled		Inspection Date: 23/11/2021		Reg. No: 103477832

<ul style="list-style-type: none"> UG10123 SALERIKA MILO (P) Polled UG12148 SALERIKA SMILO Polled UG10159 SALERIKA UG10159 A Disbudded BMB1511 BOTHASIM SMILO Polled UG0481 SALERIKA EKSELLENT Polled PN07355 LEEUPOORT LABERTINO Horned PN96195 LEEUPOORT LABE 	DAM / MOER:	<ul style="list-style-type: none"> UG0960 SALERIKA ORION 2DE Scurred UG11140 SALERIKA ESRON (P) Polled UG08112 SALERIKA UG08112 E Polled BMB148 BOTHASIM WEGKRUIP Horned Simdex: 38 Calving dates: 11/07/2021 28/06/2020 24/09/2018 ICP: 511 UG0844 SALERIKA BENNO (P) Polled UG1146 SALERIKA UG11046 B Disbudded UG0682 SALERIKA UG0682 B Disbudded
---	--------------------	---

September 2023 South African Simmentaler BREEDPLAN													Simmentaler SA – www.simmentaler.org					
2023	CED	CEM	BW	200	400	600	MCW	MILK	SC	DC	EMA	Rib	Rump	IMF%	RBY%	NFI P	SBI (R)	SPI (R)
EBV	-1.1	-0.6	+2.7	+18	+28	+33	+36	+4	--	--	--	-0.1	+0.0	--	+0.2	--	+495	+465
ACC	36%	29%	67%	45%	43%	45%	44%	31%				26%	25%		25%			
BREED	+0.3	+0.6	+1.6	+17	+27	+33	+35	+5	+0.3	-0.7	+0.3	+0.0	+0.1	+0.1	+0.2	-0.03	+481	+470

Traits observed: CE BWT

Seller's remarks / Verkoper se kommentaar:

R _____

LOT NR 6				
Verkoper	Beskrywing	Aantal	Koper	Prys
Kyksim Simmentalers	Simmentaler Bul SP	1		

*BMB 20 11

*Self in die stoet gebruik, goeie kalwingsgemak

OFFICIAL RECORD / AMPTELIKE REKORD <small>Outentiqua Intergrasveiling, 20x10/2023</small>	BOTHASIM OUBOET		BMB2011		
	BM BOTHA, POSBUS 10841 GEORGE 6530 TEL:27824402763				SIMMENTALER
	Birth Date: 03/07/2020 DNA: 8641U006, SV		Reg. Status: REG		MALE/MANLIK
	Age: 39 months Herdbook: SP Horn: Polled		Inspection Date: 23/11/2021		Reg. No: 103477915

<ul style="list-style-type: none"> UG0481 SALERIKA EKSELLENT Polled E078 ERICO EKSELARO Polled E0042 ERICO BARO DJA1049 ELLI'S OPIUM Polled UG0054 SALERIKA BAKEN Polled CE0444 SIMLEE BARONIE ** Polled PN952 LEEUPOORT BARONESS 	DAM / MOER:	<ul style="list-style-type: none"> UG10123 SALERIKA MILO (P) Polled UG12148 SALERIKA SMILO Polled UG10159 SALERIKA UG10159 A Disbudded BMB1613 BOTHASIM BMB1613 Polled Simdex: 88 Calving dates: 15/07/2021 03/07/2020 21/08/2018 ICP: 530 LH0891 MACARARA MANGA Polled BMB121 BOTHASIM HONEY Polled CSS09107 STANSIM HONEY HADAU Polled
---	--------------------	---

September 2023 South African Simmentaler BREEDPLAN													Simmentaler SA – www.simmentaler.org					
2023	CED	CEM	BW	200	400	600	MCW	MILK	SC	DC	EMA	Rib	Rump	IMF%	RBY%	NFI P	SBI (R)	SPI (R)
EBV	-1.0	+0.2	+1.1	+16	+24	+29	+28	+5	+0.6	--	--	--	--	--	--	--	+411	+427
ACC	47%	35%	69%	50%	46%	48%	47%	39%	28%									
BREED	+0.3	+0.6	+1.6	+17	+27	+33	+35	+5	+0.3	-0.7	+0.3	+0.0	+0.1	+0.1	+0.2	-0.03	+481	+470

Traits observed: CE BWT

Seller's remarks / Verkoper se kommentaar:

R _____

LOT NR 7				
Verkoper	Beskrywing	Aantal	Koper	Prys
Badsberg Stoet	Simmentaler Bul SP	1		

*BBS 2121

OFFICIAL RECORD / AMPTELIIKE REKORD

BADSBERG BLITZ (AI) BBS2121

BADSBERG STOET,P/a HOLLAND BDY TRUST POSBUS 179 RAWSONVILLE 6845 TEL:27828955371 **SIMMENTALER**

Birth Date: 30/10/2021 DNA: 13741U006, SV Reg. Status: REG MALE/MANLIK
 Age: 23 months Inspection Date: 06/10/2023
 Herdbook: SP Reg. No: 103534699
 Horn: Horned



September 2023 South African Simmentaler BREEDPLAN Simmentaler SA - www.simmentaler.org

2023	CED	CEM	BW	200	400	600	MCW	MILK	SC	DC	EMA	Rib	Rump	IMF%	RBY%	NFI P	SBI (R)	SPI (R)
EBV	+3.0	+2.2	+0.4	+12	+19	+26	+22	+2	-0.1	--	--	--	--	--	--	--	+455	+465
ACC	36%	30%	57%	58%	55%	55%	51%	39%	25%									
BREED	+0.3	+0.6	+1.6	+17	+27	+33	+35	+5	+0.3	-0.7	+0.3	+0.0	+0.1	+0.1	+0.2	-0.03	+481	+470

Traits observed: BWT 200WT 400WT 600WT
 Seller's remarks / Verkoper se kommentaar: **R**

LOT NR 8				
Verkoper	Beskrywing	Aantal	Koper	Prys
Badsberg Stoet	Simmentaler Bul SP	1		

*BBS 2126

OFFICIAL RECORD / AMPTELIIKE REKORD

BADSBERG RONKEN - Nie onder die reëls BBS2126

BADSBERG STOET,P/a HOLLAND BDY TRUST POSBUS 179 RAWSONVILLE 6845 TEL:27828955371 **SIMMENTALER**

Birth Date: 22/12/2021 DNA: Reg. Status: CBK MALE/MANLIK
 Age: 21 months Not yet inspected
 Herdbook: SP Reg. No: 103601225
 Horn: Disbudded



September 2023 South African Simmentaler BREEDPLAN Simmentaler SA - www.simmentaler.org

2023	CED	CEM	BW	200	400	600	MCW	MILK	SC	DC	EMA	Rib	Rump	IMF%	RBY%	NFI P	SBI (R)	SPI (R)
EBV	-2.4	+2.5	+2.6	+22	+34	+48	+49	+4	+0.5	--	--	--	--	--	--	--	+479	+476
ACC	33%	29%	62%	60%	61%	62%	57%	41%	28%									
BREED	+0.3	+0.6	+1.6	+17	+27	+33	+35	+5	+0.3	-0.7	+0.3	+0.0	+0.1	+0.1	+0.2	-0.03	+481	+470

Traits observed: BWT 200WT 400WT 600WT
 Seller's remarks / Verkoper se kommentaar: Is gekeur, maar vaderskap bevestiging is uitstaande - Nie onder die reëls nie **R**

LOT NR 10				
Verkoper	Beskrywing	Aantal	Koper	Prys
Sandfontein Sussex	Sussex Bul SP	1		

*PSU 210033

*BUL IS GOED AANGEPAS OP DIE VELD. GOEIE BOUVORM EN GOEIE SPEENGEWIG

*INENTINGS / DOSSERINGS : VIBRIOSE EN KNOPVELSIEKTE



Driegerasiestamboom

saamgestel deur die S.A. Stamboek- en Diereverbeteringsvereniging

SUSSEX



Naam: SANDFONTEIN FISHER

Ident. nommer: PSU 210033
Reg. nommer: 0092788850
Geboorte Datum: 30/09/21
Geslag: Manlik
DNA Nr:
INTELING: 2%
Afdeling: SP
Onderafdeling:
HORING STATUS: H

Vaar: SANDFONTEIN BAS-JAN - 08/04/17
 PSU 170002 0095308708
 Afdeling SP DNA Nr U83TU001

P.G. Vaar: EVERSAR LINE UP 1350 - 05/08/13
 CN 130050 0079320913
 Afdeling SP DNA Nr U320472

P.G. Moer: FLATDRIF GLAMOUR 435TE - 11/06/10
 AJS 100034 0071023030
 Gem TKP: 436 (6) OEK: 40 (GGV: -)
 Afdeling SP DNA Nr

Moer: HUNTERSVEI CATHLEEN 69TH - 16/07/16
 JRE 160053 0084711308
 Afdeling SP DNA Nr

M.G. Vaar: HUNTERSVEI MERVE 32ND - 03/04/11
 JRE 110004 0072945346
 Afdeling SP DNA Nr C17-13538

M.G. Moer: HUNTERSVEI CATHLEEN 57TH - 17/05/13
 JRE 130029 0077967610
 Gem TKP: 480 (5) OEK: 37 (GGV: 6.45)
 Afdeling SP DNA Nr

09/2023	KALF-GRAMAK ***		WELK ***	KALFGRASIE ***	ONDERKOP ***		GRAS-TOETS					VR-ONBAARHEID **			KOE WAARDE ***	GRAS WAARDE	PRODUKIE WAARDE
	104 54		102 43	105 52	Naapeen	Volw. gewig	GDT	Kleiber	VOV	Lengte	Hoopte	SO	OEK	TKP			
Seleksie Waarde																	
TW Indeks	104	101	102	105	108	111	105	104	-	109	101	119	88	88	101 38	-	-
Teelwaarde	0.83 52	0.4 44	6.7 43	17.7 52	36.2 54	35 18	140.9 25	96.7 25	-	42.3 22	19.9 22	21.4 22	13 21	2.1 17			
Metings	46			326 185	374 197	573 190	-	-	-	-	-	-	-	-			

LOT NR 11				
Verkoper	Beskrywing	Aantal	Koper	Prys
Spoor Angus	Rooi Angus Bul SP	1		

*LVR 21-21

*GEHARDE BULLE WAT OP STRAWWE ROOIWATER EN GALSIEK VELD GROOTGEMAAK IS.

*INENTINGS / DOSSERINGS : KNOPPESVEL, SPONS/LAM, VRUGBAARHEID GETOETS EN KUDDE SKOON VAN BM & TB



Driegerasiestamboom

saamgestel deur die S.A. Stamboek- en Diererverbeteringsvereniging

ANGUS S.A.



LOGIX

0433151000
MNR. L. VAN ROOYEN
POSBUS 7343
BLANCO
6831

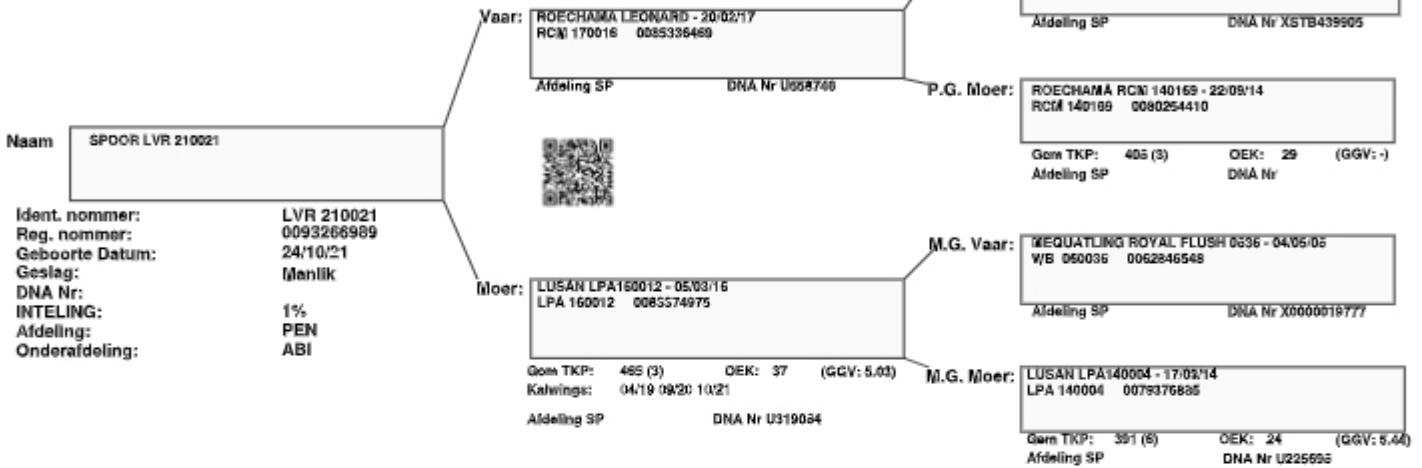

09/2023	KALFDEK		MELK	KALFDEDE	ONDERHOUD		GROEITOETS						VRUGSAARHEID			KOE WAARDE	GROE WAARDE	PROGROE WAARDE			
	****	****			***	***	***	***							****				****	****	
Seleksie Vwaarde	102 41		102 49	95 54		95 21								127 40							
	Geb gear	Geb Mat	Melk	Spore gek	Naspeen	Voik geveg	GDT	Kleier	VOV	Lengte	Hoogte	SC	OEK	TKP							
TW Indeks	97	105	102	95	93	104	82	78	87	92	101	104	130	116							
Teelwaarde	1.83 41	0.15 49	6.3 49	23.8 28	42.4 46	43.4 27	1.22 82	54.7 82	53.5 28	36 88	0.1 34	23.4 84	23.6 49	5.6 45							
Metings	33																				

LOT NR 14				
Verkoper	Beskrywing	Aantal	Koper	Prys
Viking Pony	Simmentaler Bul SP	1		

*CSS 19967

STANSIM BIGGER . Hierdie is n harde bul met mooi pigment bul met diepte en baie kapasiteit die bul het ONS SELF GEBRUIK . SY PA IS DIE BEKENDE STANSIM BIG MAC .. BIG MAC WAS DIE SIMMENTALERS SE FASE C KAMPIONEN IN 2017. BIG MAC WAS OOK DIE RESERWE JUNIOUR KAMPION VAN DIE SIMMENTALERS IN 2017. DIE SEUN VAN HOM BIGGER KOM OOK UIT DIE CONGOSIM LYN. SY OUMA IS N 2** STER EMBRIO SKENKER , MET VERSKEIE EMBRIOS KALWERS IN MY KUDDE. HIERDI BUL ,SAL IN ENIGE KUDDE N VERSKIL MAAK. EK BEVEEL HOM TEN STERKSTE AAN.

OFFICIAL RECORD / AMPTELIKE REKORD

STANSIM BIGGER		CSS19967		
STANSIM SIMMENTALERS, POSBUS 1581 FAERIE GLEN 0043 TEL:27827770250				SIMMENTALER
Birth Date: 03/09/2019		DNA: 13352U030, PV		
Age: 49 months		Reg. Status: REG		
Herdbook: SP		Inspection Date: 28/09/2020		
Horn: Horned		MALE/MANLIK		
		Reg. No: 103310686		

SIRE / VAAR:	<ul style="list-style-type: none"> JVW9820 OLINTIE BOSLUIS AB1110 RIVERVALLEY HOUSTON Horned CCE0322 VERA ORKAL ** CSS1515 STANSIM BIGMAC Horned LAT021 LATCO HAGER JUNIOR IP0643 NAWINA KARLA IP0315 NAWINA KARLIEN 2DE 	DAM / MOER:	<ul style="list-style-type: none"> BW0867 BOSWALD PATROON 67/08 Horned UG11245 SALERIKA UG11245 E Disbudded UG07162 SALERIKA UG07162 E (P) Horned UG1434 SALERIKA UG1434 B Simdex: 98 ICP: 405 Calving dates: 22/11/2022 08/01/2022 09/01/2021 03/09/2019 18/09/2018 29/07/2017 31/03/2016 SDJ9926 AI-AI MORRIS Polled MCS0815 CONGOSIM BAMBI 7DE ** Polled MCS03107 CONGOSIM BAMBI 5DE *
--------------	---	-------------	---

September 2023 South African Simmentaler BREEDPLAN														Simmentaler SA - www.simmentaler.org									
2023	CED	CEM	BW	200	400	600	MCW	MILK	SC	DC	EMA	Rib	Rump	IMF%	RBV%	NFIP	SBI (R)	SPI (R)					
EBV	-4.5	-2.3	+3.3	+22	+34	+45	+55	+4	+0.7	--	-0.1	-0.2	-0.2	+0.3	-0.1	--	+376	+410					
ACC	48%	37%	79%	84%	83%	82%	80%	39%	62%		36%	41%	41%	30%	39%								
BREED	+0.3	+0.6	+1.6	+17	+27	+33	+35	+5	+0.3	-0.7	+0.3	+0.0	+0.1	+0.1	+0.2	-0.03	+481	+470					

Traits observed: BWT 200WT 400WT SS FAT EMA IMF
 Seller's remarks / Verkoper se kommentaar: R _____

LOT NR 15				
Verkoper	Beskrywing	Aantal	Koper	Prys
Steynberg Boerdery Trust	Bonsmara Bul SP	1		

*SBT20 0011

Bonsmara SA Cattle Breeders' Society
 Compiled by the South African Stud Book and Livestock Improvement Association
 All Pedigree and Performance Data has been certified as correct.

BULLS											
STEYBERG BOERDERY											
SBT 200011 2020-08-15 SP Parentage: Sire / Dam DNA <input checked="" type="checkbox"/> Genomics <input checked="" type="checkbox"/>		HBT 170037 P 2019-08-15 SP	TOR 10020	LDW 070041 TOR 080133 2019-08-15 SP	Calving Ease Value 106	Weaner Calf Value 94	Fertility Value 97	Maintenance Value 89	Cow Value 94	Growth Value 104	Carcass Value 108
			HBT 120004 P 2019-08-15 SP	HBT 090080 2019-08-15 SP	MCU 070007 P HBT 090080 2019-08-15 SP	Calf and Mother Birth Wean Dr. Wean Mat. Sc. Cr. Harb. Fert. Calf Fert. Longm. Post. Wean. Add. FCR. Mature Weight. High. Length. EMA. Fat. Mar.	Post-Wean Growth Post. Wean. Add. FCR.	Frame High. Length.	Carcass EMA. Fat. Mar.		
			VJN 130098	GZY 090157 HH(C) 2019-08-15 SP	AG 100179	Wean index. 365D index. 540D index. ADD index. FCR index. Sireum. LH.	Myostatin Q204x Not Tested NT321 Not Tested PM1 Not Tested				
			SBT 080013 2019-08-15 SP	REMARKS:		LOGIX EBV Analysis: 2023-08-23					

LOT NR 16				
Verkoper	Beskrywing	Aantal	Koper	Prys
Steynberg Boerdery Trust	Bonsmara Bul SP	1		

*SBT20 0013

Bonsmara SA Cattle Breeders' Society
 Compiled by the South African Stud Book and Livestock Improvement Association
 All Pedigree and Performance Data has been certified as correct.

BULLE											
STEYBERG BOERDERY											
SBT 200013 2020-08-16 SP Ouerkap: Veer / Moer DNA <input checked="" type="checkbox"/> Genomics <input checked="" type="checkbox"/>		HBT 170037 P 2019-08-15 SP	TOR 10020	LDW 070041 TOR 080133 2019-08-15 SP	Gebortegemk. Waarde 100	Speenkalf Waarde 96	Vrugaarheids-waarde 93	Onderhouds-waarde 94	Koeiwaarde 91	Groei-waarde 102	Karkas-waarde 104
			HBT 120004 P 2019-08-15 SP	HBT 090080 2019-08-15 SP	MCU 070007 P HBT 090080 2019-08-15 SP	Kalf en Moeder Geb. Dr. Sps. Dr. Mar. Sc. Cr. Wee. Vrug. Harb. Fert. Calf Fert. Longm. No. Speen. Goei. Post. Wean. Add. FCR. Mature Weight. High. Length.	No. Speen. Goei. Add. FCR.	Ream High. Length.	Karkas U50. Vet. Mar.		
			VJN 130009	CEF 970089 2019-08-15 SP	LAR 070038	Wean index. 365D index. 540D index. GDT index. VBV index. Sireum. LH.	Myostatin Q204x No Getests NT321 No Getests PM1 No Getests				
			SBT 090069 2019-08-15 SP	OPMERKINGS:		LOGIX EBV Analyse: 2023-08-23					

LOT NR 16 A				
Verkoper	Beskrywing	Aantal	Koper	Prys
Steynberg Boerdery Trust	Bonsmara Bul SP	1		

*SBT20 0021

Bonsmara SA Cattle Breeders' Society
 © Compiled by the South African Stud Book and Livestock Improvement Association
 All Pedigree and Performance Data has been certified as correct

BULLE

STEYNBERG BOERDERY SBT 200021 2020-08-24 ♂ Ouerkap Year Moer DNS <input checked="" type="checkbox"/> Genomies		AT 120217 SBT 080047 2020-08-24 ♂ LEM 50/50, 945 99-24	AT 100033 EI 000031 CUBANA, 100 40M 50/50, 945	AG 050173 EI 000031 CUBANA, 100 40M 50/50, 945	WAT 030012 EI 000031 CUBANA, 100 40M 50/50, 945	Geboortegemak Waarde 105	Speenkalf Waarde 104	Vrugbaarheids waarde 90	Onderhouds waarde 111	Koelwaarde 99	Groei waarde 89	Karkas waarde 90			
Kalf en Moeder		Vrugbaarheid			Na Speen Groei			Roem			Karkas				
Geb. Dn.	Spe. Dn.	Spe. Mtr.	St. Cntr.	Vrs. Vrug.	Kal. Vrug.	Lank.	Na Speen	GOT	VGV	Vrs. Gevlg	Hoogs	Lange	DND	Vet	Har
101	99	99	112	93	99	89	102	86	100	90	104	96	88	95	90
Spe. Inleke		3650 Inleke		3400 Inleke		GOT Inleke		VGV Inleke		Skroem		LH		Mutaties	
91		107		115		-		-		-		-		Q204X No Gebort N7821 No Gebort PML No Gebort	

OPMERKINGS: LOGIX EBV Analyse: 2023-08-23

LOT NR 17				
Verkoper	Beskrywing	Aantal	Koper	Prys
Steynberg Boerdery Trust	Bonsmara Bul SP	1		

*SBT 20 0110

Bonsmara SA Cattle Breeders' Society
 © Compiled by the South African Stud Book and Livestock Improvement Association
 All Pedigree and Performance Data has been certified as correct

BULLE

STEYNBERG BOERDERY SBT 200110 2020-11-04 ♂ Ouerkap Year Moer DNS <input checked="" type="checkbox"/> Genomies		AT 120217 SBT 180016 2020-11-04 ♂ 40M 50/50, 945 100-1	AT 100033 EI 000031 CUBANA, 100 40M 50/50, 945	AG 050173 EI 000031 CUBANA, 100 40M 50/50, 945	WAT 030012 EI 000031 CUBANA, 100 40M 50/50, 945	Geboortegemak Waarde 98	Speenkalf Waarde 103	Vrugbaarheids waarde 98	Onderhouds waarde 103	Koelwaarde 102	Groei waarde 94	Karkas waarde 93			
Kalf en Moeder		Vrugbaarheid			Na Speen Groei			Roem			Karkas				
Geb. Dn.	Spe. Dn.	Spe. Mtr.	St. Cntr.	Vrs. Vrug.	Kal. Vrug.	Lank.	Na Speen	GOT	VGV	Vrs. Gevlg	Hoogs	Lange	DND	Vet	Har
96	100	106	111	101	102	91	103	90	100	95	109	103	90	97	95
Spe. Inleke		3650 Inleke		3400 Inleke		GOT Inleke		VGV Inleke		Skroem		LH		Mutaties	
125		112		103		-		-		-		-		Q204X No Gebort N7821 No Gebort PML No Gebort	

OPMERKINGS: LOGIX EBV Analyse: 2023-08-23

LOT NR 18				
Verkoper	Beskrywing	Aantal	Koper	Prys
Kyksim Simmentalers	Simmentaler Bul SP	1		

*BMB 20 7

*Die bul is gebruik om verse mee oop te maak. Goeie kalwingsgemak

OFFICIAL RECORD / AMPTELIKE REKORD
Outeniqua Interrasveiling, 20/10/2023

BOTHASIM OUPA		BMB207																
BM BOTHA, POSBUS 10841 GEORGE 6530 TEL:27824402763		SIMMENTALER																
Birth Date: 01/07/2020	DNA: 8641U009, SV	Reg. Status: REG	MALE/MANLIK															
Age: 39 months		Inspection Date: 23/11/2021	Reg. No: 103477873															
Herdbook: SP																		
Horn: Polled																		
<p>SIRE / VAAR:</p> <ul style="list-style-type: none"> UG0481 SALERIKA EKSELLENT Polled <li style="padding-left: 20px;">E078 ERICO EKSELARO Polled E0042 ERICO BARO <li style="padding-left: 20px;">DJA1049 ELLI'S OPIUM Polled UG0054 SALERIKA BAKEN Polled <li style="padding-left: 20px;">CE0444 SIMLEE BARONIE ** Polled PN952 LEEUPOORT BARONESS 		<p>DAM / MOER:</p> <ul style="list-style-type: none"> JV098 ALVOS MICH Horned ADC124 KAALDOORNS RHINO Polled ADC0947 KAALDOORNS ABRIAMA *** Polled CSS1579 STANSIM PIXIE Polled <li style="padding-left: 20px;">Calving dates: 16/07/2021 01/07/2020 15/05/2018 ADC0938 KAALDOORNS ABD Horned ADC1292 KAALDOORNS WINNIE Horned ADC0892 KAALDOORNS ABE Horned 																
September 2023 South African Simmentaler BREEDPLAN		Simmentaler SA – www.simmentaler.org																
2023	CED	CEM	BW	200	400	600	MCW	MILK	SC	DC	EMA	Rib	Rump	IMF%	RBV%	NFI P	SBI (R)	SPI (R)
EBV	+0.4	+1.3	+0.8	+13	+20	+26	+25	+5	+0.4	--	--	--	--	--	--	--	+400	+425
ACC	40%	34%	69%	49%	46%	48%	47%	37%	25%									
BREED	+0.3	+0.6	+1.6	+17	+27	+33	+35	+5	+0.3	-0.7	+0.3	+0.0	+0.1	+0.1	+0.2	-0.03	+481	+470
Traits observed: CE BWT Seller's remarks / Verkoper se kommentaar:		R _____																

LOT NR 19				
Verkoper	Beskrywing	Aantal	Koper	Prys
Kyksim Simmentalers	Simmentaler Bul SP	1		

*BMB 21 29

*Kykso Kaino seun. 'n Bul met baie goeie lengte en groei

OFFICIAL RECORD / AMPTELIKE REKORD

BOTHASIM WILLIE		BMB2129																
BM BOTHA, POSBUS 10841 GEORGE 6530 TEL:27824402763		SIMMENTALER																
Birth Date: 25/08/2021	DNA: 8022U002, PV	Reg. Status: REG	MALE/MANLIK															
Age: 25 months		Inspection Date: 18/10/2022	Reg. No: 103591376															
Herdbook: SP																		
Horn: Horned																		
<p>SIRE / VAAR:</p> <ul style="list-style-type: none"> MS229 KYKSO KAIMAT 73 <li style="padding-left: 20px;">MS8623 KYKSO KADAM 86 MS841 KYKSO DAMPE 84 *** <li style="padding-left: 20px;">MS9933 KYKSO KAINO MS88118 KYKSO HADAU <li style="padding-left: 20px;">MS94144 KYKSO NOHA MS8519 KYKSO NOLHEI 85 		<p>DAM / MOER:</p> <ul style="list-style-type: none"> PN0260 LEEUPOORT LASTIG PN07147 LEEUPOORT BRITS Horned UG9946 SALERIKA BRITTA WDW144 LOCHEIM SISKA <li style="padding-left: 20px;">Calving dates: 25/08/2021 18/08/2021 07/07/2020 20/10/2018 15/06/2017 30/07/2016 CO03817 BAR 5 S.A. PIONA 04 817N WDW1137 LOCHEIM SISKA Horned WDW0931 LOCHEIM NONAME * Polled 																
		Simmentaler SA – www.simmentaler.org																
2023	CED	CEM	BW	200	400	600	MCW	MILK	SC	DC	EMA	Rib	Rump	IMF%	RBV%	NFI P	SBI (R)	SPI (R)
EBV																		
ACC																		
BREED										-0.7								
Traits observed: Seller's remarks / Verkoper se kommentaar:		R _____																

Geen geboortegewig teelwaarde - Nie onder die reëls nie

LOT NR 20				
Verkoper	Beskrywing	Aantal	Koper	Prys
Kyksim Simmentalers	Simmentaler Bul SP	1		

*KS 20 5

*Goeie lengte en bespieroing

KYKSIM BALLAS

KS205

BM BOTHA, POSBUS 10841 GEORGE 6530 TEL:27824402763

SIMMENTALER

Birth Date: 16/07/2020

DNA: 8640U005, SV

Reg. Status: REG

MALE/MANLIK

Age: 39 months

Inspection Date: 23/11/2021

Herdbook: SP

Reg. No: 103478186

Horn: Polled

SIRE / VAAR:



DAM / MOER:



September 2023 South African Simmentaler BREEDPLAN

Simmentaler SA - www.simmentaler.org

2023	CED	CEM	BW	200	400	600	MCW	MILK	SC	DC	EMA	Rib	Rump	IMF%	RBV%	NFI P	SBI (R)	SPI (R)
EBV	+1.3	-0.7	+1.2	+14	+21	+24	+31	+3	-0.1	--	--	--	--	--	--	--	+377	+421
ACC	35%	28%	64%	41%	40%	42%	42%	31%	27%									
BREED	+0.3	+0.6	+1.6	+17	+27	+33	+35	+5	+0.3	-0.7	+0.3	+0.0	+0.1	+0.1	+0.2	-0.03	+481	+470

Traits observed: CE BWT

Seller's remarks / Verkoper se kommentaar:

R _____

OFFICIAL RECORD / AMPTELIKE REKORD



LOT NR 21				
Verkoper	Beskrywing	Aantal	Koper	Prys
Spoor Angus	Rooi Angus Bul SP	1		

*LVR 21-30

*GEHARDE BULLE WAT OP STRAWWE ROOIWATER EN GALSIEK VELD GROOTGEMAAK IS.

*INENTINGS / DOSSERINGS : KNOPPIESVEL, SPONS/LAM, VRUGBAARHEID GETOETS EN KUDDE SKOON VAN BM & TB



SA STAMBOEK
STUD BOOK

NAME: SPOOR LVR 210030
REGNO: 0093267086
IDNO: AANMLVR 210030

BREED: ANGUS S.A.

compiled by S.A. Stud Book and Animal Improvement Association



D.O.B. 2021/10/20 **STATUS:** REG
SEX: MALE **HERDBOOK SECTION:** PEN
LABNO: -

OWNER: MNR. L. VAN ROOYEN **ADDRESS:** MNR. L. VAN ROOYEN, POSBUS 7343, BLANCO, 6531

BREEDER: MNR. L. VAN ROOYEN **ADDRESS:** MNR. L. VAN ROOYEN, POSBUS 7343, BLANCO, GEORGE, 6531

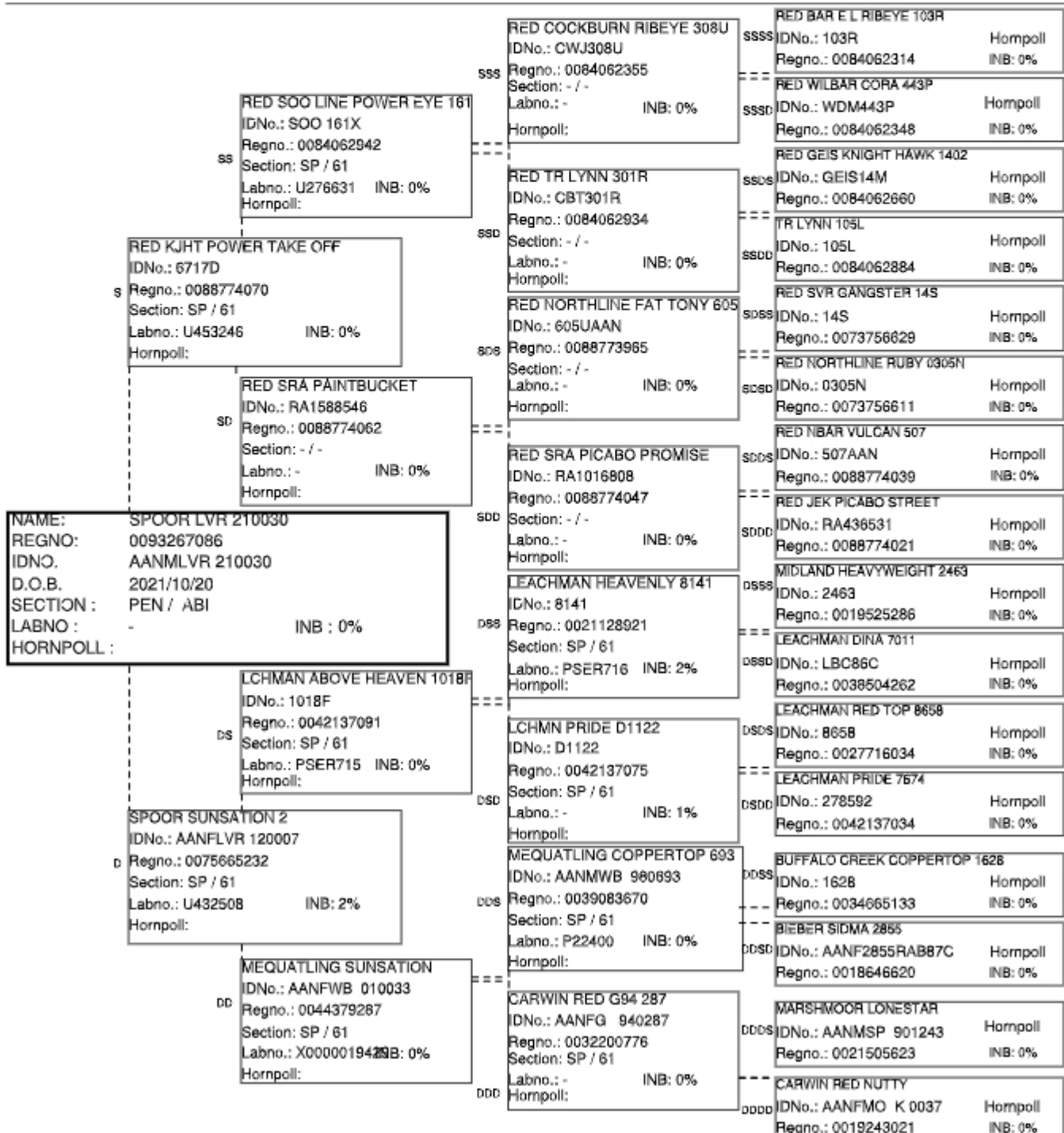

LOT NR 22				
Verkoper	Beskrywing	Aantal	Koper	Prys
Viking Pony	Simmentaler Bul SP	1		

*CSS 21201

STANSIM KOLBE. Hierdie is n harde bul met mooi pigment bul met diepte en baie kapasiteit die bul het ONS SELF GEBRUIK . SY PA IS DIE BEKENDE STANSIM BIG MAC . BIG MAC WAS DIE SIMMENTALERS SE FASE C KAMPIOEN IN 2017. BIG MAC WAS OOK DIE RESERWE JUNIOUR KAMPION VAN DIE SIMMENTALERS IN 2017. DIE BUL HET EK SELF GEBRUIK IN MY KUDDE OOK. BUL WAT GEMAKLIK BEWEEG SY MA IS DIE BEKEND DE VIL CATTRYN JPD 1064 . BUL MET GOEIE SYFERS WAT OOK BRONS MERIETE GEKRY HET BY FASE C

STANSIM KOLBE – Nie onder die reëls

CSS21201

STANSIM SIMMENTALERS, POSBUS 1581 FAERIE GLEN 0043 TEL:27827770250

SIMMENTALER

Birth Date: 25/01/2021 DNA:

Reg. Status: CBK

MALE/MANLIK

Age: 32 months

Not yet inspected

Herdbook: SP

Reg. No: 103516746

Horn: Polled

SIRE / VAAR:

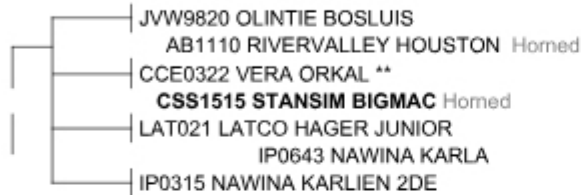

DAM / MOER:



September 2023 South African Simmentaler BREEDPLAN

Simmentaler SA – www.simmentaler.org

2023	CED	CEM	BW	200	400	600	MCW	MILK	SC	DC	EMA	Rib	Rump	IMF%	RBY%	NFI P	SBI (R)	SPI (R)
EBV	-0.3	-1.0	+1.8	+17	+25	+31	+33	+4	+0.6	-0.5	--	-0.1	+0.0	--	+0.2	--	+459	+446
ACC	41%	36%	67%	49%	48%	50%	49%	43%	33%	26%		27%	27%		27%			
BREED	+0.3	+0.6	+1.6	+17	+27	+33	+35	+5	+0.3	-0.7	+0.3	+0.0	+0.1	+0.1	+0.2	-0.03	+481	+470

Traits observed: BWT NFI-P



Seller's remarks / Verkoper se kommentaar:

Is gekeur, maar vaderskap bevestiging is uitstaande - Nie onder die reëls nie

R

LOT NR 23				
Verkoper	Beskrywing	Aantal	Koper	Prys
Knoetzekamma Limousines	Limousin Vers SP	1		

*JJ18 17

*INENTINGS / DOSSERINGS : RB51, PILLIGUARD, SUPAVAX, LUMPY SKIN, CATTLE MASTER

*SHE IS 7.5 MONTHS PREGNANT FROM JJ1923. SHE IS A THICK MEDIUM FRAME COW THAT HAS BRED TWO TOP HEIFERS FOR US.

Limousin Animal Details

KNOETZEKAMMA INA CADETTE

Identification: JJ1817
Sex: Female
Birth Date: 26/08/2018
Computer Number: 8797167254
HerdBook: SP **Inspection Date:** 08/06/20
Status: Active
Registration Status: Registered
Breeder: [J.J. WATSON](#)
Current Owner: [J.J. WATSON](#)
Reproduction: ICP = 446 AFC = 34 DLC = 361
By AI: Sire Verified #488921
Progeny [\[2 - View\]](#)
EBV Graph: [\[View\]](#)

— [VERGESIGTE 0210 DAUPHIN](#)
 — [LA RHONE EAGLE](#)
 — [GRANDE FOUR CANDY EUREMIS LUCY](#)
 — **Sire:** [JACRE CAESER](#)
 — [GRANDE FOUR BLADE](#)
 — [JACRE SCOTLAND](#)
 — [JACRE MOODY VG0171](#)
Animal: [KNOETZEKAMMA INA CADETTE](#)
 — [KNOETZEKAMMA AG-GENEE](#)
 — [KNOETZEKAMMA DIKGAT GENOEG](#)
 — [KNOETZEKAMMA SONIE 1](#)
 — **Dam:** [KNOETZEKAMMA BERLIA CADETTE](#)
 — [VERGESIGTE CHOICE EUREMIS](#)
 — [KNOETZEKAMMA CADETTE](#)
 — [KNOETZEKAMMA RHONA 10](#)

September 2023 Southern Limousin BREEDPLAN

	Calving Ease DIR (%)	Calving Ease DTRS (%)	Gestation Length (days)	Birth Wt. (kg)	200 Day Wt (kg)	400 Day Wt (kg)	600 Day Wt (kg)	Mat Cow Wt (kg)	Milk (kg)	Scrotal Size (cm)	Carcase Wt (kg)	Eye Muscle Area (sq cm)	Rib Fat (mm)	Rump Fat (mm)	Retail Beef Yield (%)	IMF (%)	Docility (%)
EBV	+1.3	-0.1	-0.2	+1.2	+10	+21	+18	+23	+5	+0.2	+15	-	-	-	-	-	-5
Accuracy	34%	25%	38%	70%	65%	67%	72%	69%	49%	39%	51%	-	-	-	-	-	35%
Breed Avg. EBVs for 2021 Born Calves Click for Percentiles																	
EBV	+0.5	+0.8	-2.1	+1.7	+21	+35	+49	+48	+7	+1.1	+31	+1.8	+0.0	-0.1	+0.8	+0.0	+42

Traits Analysed: BWT,200WT,400WT,600WT,MWT,DOC

Statistics: Number of Herds: 1, Progeny Analysed: 2,

LOT NR 24				
Verkoper	Beskrywing	Aantal	Koper	Prys
Knoetzekamma Limousines	Limousin Vers SP	1		

*JJ19 21

*INENTINGS / DOSSERINGS : RB51, PILLIGUARD, SUPAVAX, LUMPY SKIN, CATTLE MASTER

*HER SIRE IS A MAS DU CLO SON AND FROM THE VERY FERTILE FLEUR MATERNAL LINE. ON THE DAM SIDE THERE IS BON CHANCE ETOR AND GENIAL.

Limousin Animal Details

KNOETZEKAMMA JENIFER GRETA

Identification: JJ1921
Sex: Female
Birth Date: 01/10/2019
Computer Number: 8797187096
HerdBook: SP **Inspection Date:** 19/03/21
Status: Active
Registration Status: Registered
Breeder: [J.J. WATSON](#)
Current Owner: [J.J. WATSON](#)
Reproduction: ICP = n/a AFC = 36 DLC = 365
By AI: Sire Verified #402U015
Progeny [\[1 - View\]](#)
EBV Graph: [\[View\]](#)

— [BAMBINO](#)
 — [MAS DU CLO](#)
 — [COSETTE](#)
 — **Sire:** [KNOETZEKAMMA GOODMAN](#)
 — [LA RHONE JACKNIFE](#)
 — [KNOETZEKAMMA DELILA FLEUR](#)
 — [BON CHANCE FARI](#)
Animal: [KNOETZEKAMMA JENIFER GRETA](#)
 — [GWENOLE](#)
 — [KNOETZEKAMMA AROSTOCRAT](#)
 — [KNOETZEKAMMA ETOR POWER](#)
 — **Dam:** [KNOETZEKAMMA BELINDA GRETA](#)
 — [KNOETZEKAMMA](#)
 — [KNOETZEKAMMA GRETTA GENAIL](#)
 — [KNOETZEKAMMA RHONA 2](#)

September 2023 Southern Limousin BREEDPLAN																		
	Calving Ease DIR (%)	Calving Ease DTRS (%)	Gestation Length (days)	Birth Wt. (kg)	200 Day Wt (kg)	400 Day Wt (kg)	600 Day Wt (kg)	Mat Cow Wt (kg)	Milk (kg)	Scrotal Size (cm)	Carcase Wt (kg)	Eye Muscle Area (sq cm)	Rib Fat (mm)	Rump Fat (mm)	Retail Beef Yield (%)	IMF (%)	Docility (%)	
EBV	-4.0	-1.8	+1.5	+2.3	+16	+19	+21	+31	+3	+0.5	+13	-	-0.1	-0.6	+0.8	-	-	
Accuracy	32%	25%	39%	68%	64%	66%	70%	57%	50%	46%	50%	-	27%	26%	25%	-	-	
Breed Avg. EBVs for 2021 Born Calves Click for Percentiles																		
EBV	+0.5	+0.8	-2.1	+1.7	+21	+35	+49	+48	+7	+1.1	+31	+1.8	+0.0	-0.1	+0.8	+0.0	+42	

Traits Analysed: BWT,200WT,400WT,600WT,MWT
Statistics: Number of Herds: 1, Progeny Analysed: 1,

LOT NR 25				
Verkoper	Beskrywing	Aantal	Koper	Prys
Knoetzekamma Limousines	Limousin Vers SP met bulkalf	1+1		

*JJ18 19

*INENTINGS / DOSSERINGS : RB51, PILLIGUARD, SUPAVAX, LUMPY SKIN, CATTLE MASTER

*SHE IS AN EXCELLENT DAM WITH ICP OF 381 DAYS. HER OWN ICP IS 351 DAYS. SHE IS SOLD WITH A VERY THICK BULL CALF FROM JJ 1923

Limousin Animal Details

KNOETZEKAMMA INNOCENT DUCH

Identification: JJ1819
Sex: Female
Birth Date: 09/09/2018
Computer Number: 8797167288
HerdBook: SP **Inspection Date:** 08/06/20
Status: Active
Registration Status: Registered
Breeder: [J.J. WATSON](#)
Current Owner: [J.J. WATSON](#)
Reproduction: ICP = 351 AFC = 36 DLC = 36
By AI: Sire Verified #488922
Progeny [\[3 - View\]](#)
EBV Graph: [\[View\]](#)

— [VERGESIGTE 0210 DAUPHIN](#)

— [LA RHONE EAGLE](#)

— [GRANDE FOUR CANDY EUREMIS LUCY](#)

— **Sire:** [JACRE CAESER](#)

— [GRANDE FOUR BLADE](#)

— [JACRE SCOTLAND](#)

— [JACRE MOODY VG0171](#)

Animal: [KNOETZEKAMMA INNOCENT DUCH](#)

— [BON CHANCE GENOEG 80](#)

— [KNOETZEKAMMA AG-GENEE](#)

— [KNOETZEKAMMA KNOETZE POWER GIRL](#)

— **Dam:** [KNOETZEKAMMA ANGEL DUCH](#)

— [COCO DUCHSON](#)

— [COCO DUCH RADOON 19](#)

— [COCO TARVIS RACOON](#)

September 2023 Southern Limousin BREEDPLAN

	Calving Ease DIR (%)	Calving Ease DTRS (%)	Gestation Length (days)	Birth Wt. (kg)	200 Day Wt (kg)	400 Day Wt (kg)	600 Day Wt (kg)	Mat Cow Wt (kg)	Milk (kg)	Scrotal Size (cm)	Carcase Wt (kg)	Eye Muscle Area (sq cm)	Rib Fat (mm)	Rump Fat (mm)	Retail Beef Yield (%)	IMF (%)	Docility (%)
EBV	+0.9	+0.2	0.0	+1.8	+14	+22	+28	+27	+6	+0.4	+18	-	-	-	-	-	+20
Accuracy	36%	25%	39%	70%	66%	67%	71%	57%	49%	39%	50%	-	-	-	-	-	31%
Breed Avg. EBVs for 2021 Born Calves Click for Percentiles																	
EBV	+0.5	+0.8	-2.1	+1.7	+21	+35	+49	+48	+7	+1.1	+31	+1.8	+0.0	-0.1	+0.8	+0.0	+42

Traits Analysed: BWT,200WT,400WT,600WT,MWT,DOC

Statistics: Number of Herds: 1, Progeny Analysed: 3,

LOT NR 26				
Verkoper	Beskrywing	Aantal	Koper	Prys
Knoetzekamma Limousines	Limousin Vers SP	1		

*JJ21 23

*INENTINGS / DOSSERINGS : RB51, PILLIGUARD, SUPAVAX, LUMPY SKIN, CATTLE MASTER

*SHE IS A LA RHONE REBEL DAUGHTER. ON THE DAM SIDE THERE IS MAS DU CLO

Limousin Animal Details

KNOETZEKAMMA LILLIAN GRETA

Identification: JJ2123
Sex: Female
Birth Date: 05/11/2021
Computer Number: 8797240689
HerdBook: SP **Inspection Date:** 09/05/23
Status: Active
Registration Status: Registered
Breeder: J.J. WATSON
Current Owner: J.J. WATSON
Reproduction: ICP = n/a AFC = n/a DLC = n/a
By AI: Sire Verified #12315U017
Progeny: None
EBV Graph: [\[View\]](#)

— WILZAK 02102 ZIP MAN
 — LA RHONE HITMAN
 — XCELBO TANGOLINE
 — **Sire:** LA RHONE REBEL
 — DEVLAN LENGTH 04 104
 — DEVLAN LONG MUSCLE 08 112
 — DEVLAN 00 140

Animal: KNOETZEKAMMA LILLIAN GRETA

— WILZAK 0431 MANSEL
 — HENBASE MAMEY
 — MEA-WEST 9919
 — **Dam:** KNOETZEKAMMA FOREST GRETA
 — KNOETZEKAMMA
 — KNOETZEKAMMA GRETTA GENAIL
 — KNOETZEKAMMA RHONA 2

September 2023 Southern Limousin BREEDPLAN																	
	Calving Ease DIR (%)	Calving Ease DTRS (%)	Gestation Length (days)	Birth Wt. (kg)	200 Day Wt (kg)	400 Day Wt (kg)	600 Day Wt (kg)	Mat Cow Wt (kg)	Milk (kg)	Scrotal Size (cm)	Carcase Wt (kg)	Eye Muscle Area (sq cm)	Rib Fat (mm)	Rump Fat (mm)	Retail Beef Yield (%)	IMF (%)	Docility (%)
EBV	-2.5	-0.3	+1.3	+2.6	+18	+24	+34	+39	+5	+0.8	+18	+0.4	+0.1	-0.4	+0.5	-0.1	-
Accuracy	37%	26%	44%	70%	65%	66%	71%	57%	45%	44%	51%	28%	33%	31%	30%	27%	-
Breed Avg. EBVs for 2021 Born Calves Click for Percentiles																	
EBV	+0.5	+0.8	-2.1	+1.7	+21	+35	+49	+48	+7	+1.1	+31	+1.8	+0.0	-0.1	+0.8	+0.0	+42
Traits Analysed: BWT,200WT,400WT,600WT																	

LOT NR 27				
Verkoper	Beskrywing	Aantal	Koper	Prys
Knoetzekamma Limousines	Limousin Vers SP	1		

*JJ21 29

*INENTINGS / DOSSERINGS : RB51, PILLIGUARD, SUPAVAX, LUMPY SKIN, CATTLE MASTER

*SHE IS A LA RHONE REBEL DAUGHTER AND FROM THE BALOTE MATERNAL LINE

Limousin Animal Details

KNOETZEKAMMA LUCIA BELOTE

Identification: JJ2129
Sex: Female
Birth Date: 20/11/2021
Computer Number: 8797241414
HerdBook: SP **Inspection Date:** 09/05/23
Status: Active
Registration Status: Registered
Breeder: J.J. WATSON
Current Owner: J.J. WATSON
Reproduction: ICP = n/a AFC = n/a DLC = n/a
By AI: Sire Verified #12315U023
Progeny: None
EBV Graph: [\[View\]](#)

— [WILZAK 02102 ZIP MAN](#)

— [LA RHONE HITMAN](#)

— [XCELBO TANGOLINE](#)

— **Sire:** [LA RHONE REBEL](#)

— [DEVLAN LENGTH 04 104](#)

— [DEVLAN LONG MUSCLE 08 112](#)

— [DEVLAN 00 140](#)

Animal: [KNOETZEKAMMA LUCIA BELOTE](#)

— [KNOETZEKAMMA AG-GENEE](#)

— [KNOETZEKAMMA DIKGAT GENOEG](#)

— [KNOETZEKAMMA SONIE 1](#)

— **Dam:** [KNOETZEKAMMA BETSIE BALOTE](#)

— [WANITA POWER PLUS 2](#)

— [KNOETZEKAMMA KNOETZE POWER GIRL](#)

— [KNOETZEKAMMA BELOTE](#)

September 2023 Southern Limousin BREEDPLAN

	Calving Ease DIR (%)	Calving Ease DTRS (%)	Gestation Length (days)	Birth Wt. (kg)	200 Day Wt (kg)	400 Day Wt (kg)	600 Day Wt (kg)	Mat Cow Wt (kg)	Milk (kg)	Scrotal Size (cm)	Carcase Wt (kg)	Eye Muscle Area (sq cm)	Rib Fat (mm)	Rump Fat (mm)	Retail Beef Yield (%)	IMF (%)	Docility (%)
	EBV	+0.1	+0.5	+1.0	+1.2	+10	+11	+12	+7	+5	+0.3	+9	-0.8	0.0	-0.4	+0.2	-0.1
Accuracy	37%	27%	44%	70%	65%	67%	72%	59%	46%	45%	52%	28%	34%	32%	31%	27%	-
Breed Avg. EBVs for 2021 Born Calves Click for Percentiles																	
EBV	+0.5	+0.8	-2.1	+1.7	+21	+35	+49	+48	+7	+1.1	+31	+1.8	+0.0	-0.1	+0.8	+0.0	+42

Traits Analyed: BWT,200WT,400WT,600WT

LOT NR 28				
Verkoper	Beskrywing	Aantal	Koper	Prys
Kyksim Simmentalers	Simmentaler Vers SP	1		

*BMB 21 113

*Dragtigheid: 45 Dae

OFFICIAL RECORD / AMPTELIKE REKORD	BOTHASIM HONEY		BMB21113																
	BM BOTHA, POSBUS 10841 GEORGE 6530 TEL:27824402763				SIMMENTALER														
	Birth Date: 15/07/2021	Simdex: ,	Star:	Reg. Status: REG	FEMALE/VROULIK														
	Age: 27 months	Days last calved:	ICP:	Inspection Date: 18/10/2022															
	Herdbook: SP	Calvings:			Reg. No: 103591236														
	Horn: Horned	Calving dates:																	
	SIRE / VAAR:	KS1125 KYKSIM PETKA Scurred BMB1386 BOTHASIM PETKA Polled ACM1036 MILAGRO SANTJIE 1036 Polled BMB169 BOTHASIM PETKA Polled UG056 SALERIKA MENTOR Polled CE0951 SIMLEE MONSA * Horned CE06133 SIMLEE SALRI		DAM / MOER:	UG10123 SALERIKA MILO (P) Polled UG12148 SALERIKA SMILO Polled UG10159 SALERIKA UG10159 A Disbudded BMB1613 BOTHASIM BMB1613 Polled Simdex: 88 ICP: 530 Calving dates: 15/07/2021 03/07/2020 21/08/2018 LH0891 MACARARA MANGA Polled BMB121 BOTHASIM HONEY Polled CSS09107 STANSIM HONEY HADAU Polled														
	September 2023 South African Simmentaler BREEDPLAN				Simmentaler SA-- www.simmentaler.org														
	2023	CED	CEM	BW	200	400	600	MCW	MILK	SC	DC	EMA	Rib	Rump	IMF%	RBV%	NFI P	SBI (R)	SPI (R)
	EBV	+0.7	--	+1.7	+18	+26	+29	+29	+6	--	--	--	--	--	--	--	--	--	--
ACC	29%		50%	54%	48%	47%	44%	29%											
BREED	+0.3	+0.6	+1.6	+17	+27	+33	+35	+5	+0.3	-0.7	+0.3	+0.0	+0.1	+0.1	+0.2	-0.03	+481	+470	
Traits observed: CE 200WT				Seller's remarks / Verkoper se kommentaar:					R _____										

LOT NR 29				
Verkoper	Beskrywing	Aantal	Koper	Prys
Kyksim Simmentalers	Simmentaler Vers SP	1		

*BMB 21 14

*Dragtigheid: 45 Dae

OFFICIAL RECORD / AMPTELIKE REKORD	BOTHASIM PIXY		BMB2114																
	BM BOTHA, POSBUS 10841 GEORGE 6530 TEL:27824402763				SIMMENTALER														
	Birth Date: 16/07/2021	Simdex: ,	Star:	Reg. Status: REG	FEMALE/VROULIK														
	Age: 27 months	Days last calved:	ICP:	Inspection Date: 18/10/2022															
	Herdbook: SP	Calvings:			Reg. No: 103591244														
	Horn: Polled	Calving dates:																	
	SIRE / VAAR:	KS1125 KYKSIM PETKA Scurred BMB1386 BOTHASIM PETKA Polled ACM1036 MILAGRO SANTJIE 1036 Polled BMB169 BOTHASIM PETKA Polled UG056 SALERIKA MENTOR Polled CE0951 SIMLEE MONSA * Horned CE06133 SIMLEE SALRI		DAM / MOER:	JV098 ALVOS MICH Horned ADC124 KAALDOORNS RHINO Polled ADC0947 KAALDOORNS ABRIAMA *** Polled CSS1579 STANSIM PIXIE Polled Simdex: 73 ICP: 579 Calving dates: 16/07/2021 01/07/2020 15/05/2018 ADC0938 KAALDOORNS ABD Horned ADC1292 KAALDOORNS WINNIE Horned ADC0892 KAALDOORNS ABE Horned														
	September 2023 South African Simmentaler BREEDPLAN				Simmentaler SA-- www.simmentaler.org														
	2023	CED	CEM	BW	200	400	600	MCW	MILK	SC	DC	EMA	Rib	Rump	IMF%	RBV%	NFI P	SBI (R)	SPI (R)
	EBV	+1.0	--	+1.7	+16	+23	+28	+27	+6	--	--	--	--	--	--	--	--	--	--
ACC	29%		50%	53%	47%	47%	44%	27%											
BREED	+0.3	+0.6	+1.6	+17	+27	+33	+35	+5	+0.3	-0.7	+0.3	+0.0	+0.1	+0.1	+0.2	-0.03	+481	+470	
Traits observed: CE 200WT				Seller's remarks / Verkoper se kommentaar:					R _____										

LOT NR 30				
Verkoper	Beskrywing	Aantal	Koper	Prys
Kyksim Simmentalers	Simmentaler Vers SP	1		

*KS 21 13

*Dragtigheid: 30 Dae

OFFICIAL RECORD / AMPTELIKE REKORD

KYKSIM MARSHA (AI) (ET)		KS2113		
BM BOTHA, POSBUS 10841 GEORGE 6530 TEL:27824402763				SIMMENTALER
Birth Date: 29/06/2021	Simdex: ,	Star:	Reg. Status: CBK	FEMALE/VROULIK
Age: 27 months	Days last calved:	ICP:	Not yet inspected	
Herdbook: SP	Calvings:			Reg. No: 103591517
Horn:	Calving dates:			

SIRE / VAAR:	<ul style="list-style-type: none"> MS229 KYKSO KAIMAT 73 MS97204 KYKSO K AidAM MS841 KYKSO DAMPE 84 *** KS02104 KYKSIM KAAAN MS9624 KYKSO KADAT KS0099 KYKSIM ANPRED A MS92123 KYKSO ANPRE 	DAM / MOER:	<ul style="list-style-type: none"> KS028 KYKSIM BANOL KS084 KYKSIM OSKER Horned KS0269 KYKSIM MORANG *** KS1153 KYKSIM MASKER Simdex: 57 ICP: 596 Calving dates: 31/08/2022 29/06/2021 26/06/2021 22/04/2020 15/08/2018 27/02/2017 01/04/2016 07/07/2014 KS028 KYKSIM BANOL KS0813 KYKSIM MALBA Horned MS9855 KYKSO MALMI
---------------------	--	--------------------	--

September 2023 South African Simmentaler BREEDPLAN										Simmentaler SA-- www.simmentaler.org									
2023	CED	CEM	BW	200	400	600	MCW	MILK	SC	DC	EMA	Rib	Rump	IMF%	RBV%	NFI P	SBI (R)	SPI (R)	
EBV	+1.1	+1.2	+0.5	+8	+12	+15	+13	+6	-0.1	--	--	--	--	--	--	--	+362	+390	
ACC	44%	40%	60%	51%	49%	50%	48%	47%	26%										
BREED	+0.3	+0.6	+1.6	+17	+27	+33	+35	+5	+0.3	-0.7	+0.3	+0.0	+0.1	+0.1	+0.2	-0.03	+461	+470	

Traits observed: 200WT

Seller's remarks / Verkoper se kommentaar:

R _____

LOT NR 31				
Verkoper	Beskrywing	Aantal	Koper	Prys
Kyksim Simmentalers	Simmentaler Vers SP	1		

*BMB 21 23

*by bul geloop

OFFICIAL RECORD / AMPTELIKE REKORD

BOTHASIM MOOITJIE		BMB2123		
BM BOTHA, POSBUS 10841 GEORGE 6530 TEL:27824402763				SIMMENTALER
Birth Date: 12/08/2021	Simdex: ,	Star:	Reg. Status: REG	FEMALE/VROULIK
Age: 26 months	Days last calved:	ICP:	Inspection Date: 18/10/2022	
Herdbook: SP	Calvings:			Reg. No: 103591301
Horn: Horned	Calving dates:			

SIRE / VAAR:	<ul style="list-style-type: none"> UG10123 SALERIKA MILO (P) Polled UG12148 SALERIKA SMILO Polled UG10159 SALERIKA UG10159 A Disbudded BMB1511 BOTHASIM SMILO Polled UG0481 SALERIKA EKSELLENT Polled PN07355 LEEUPOORT LABERTINO Horned PN96195 LEEUPOORT LABE 	DAM / MOER:	<ul style="list-style-type: none"> DJA094 ELLI'S ENDRICUS (ET) Polled BMB1326 BOTHASIM KENSINGTON Polled KS0587 KYKSIM KAAG *** BMB1620 BOTHASIM MOIRA Horned Simdex: 48 ICP: 413 Calving dates: 12/08/2021 25/06/2020 AVA0933 RAAP N SKRAAP VAUGHN Horned BMB1351 BOTHASIM Mooisie Polled PN08491 LEEUPOORT MOOIZ Horned
---------------------	---	--------------------	--

September 2023 South African Simmentaler BREEDPLAN										Simmentaler SA-- www.simmentaler.org									
2023	CED	CEM	BW	200	400	600	MCW	MILK	SC	DC	EMA	Rib	Rump	IMF%	RBV%	NFI P	SBI (R)	SPI (R)	
EBV	-0.9	-1.2	+2.1	+15	+22	+26	+29	+5	--	--	--	--	--	--	--	--	--	--	
ACC	36%	29%	54%	41%	37%	39%	36%	29%											
BREED	+0.3	+0.6	+1.6	+17	+27	+33	+35	+5	+0.3	-0.7	+0.3	+0.0	+0.1	+0.1	+0.2	-0.03	+461	+470	

Traits observed: CE

Seller's remarks / Verkoper se kommentaar:

R _____

LOT NR 32				
Verkoper	Beskrywing	Aantal	Koper	Prys
Kyksim Simmentalers	Simmentaler Vers Dragtig SP	1		

*BMB 21 38

*5 maande dragtig

OFFICIAL RECORD / AMPTELIKE REKORD

BOTHASIM BETTIE		BMB2138		
BM BOTHA, POSBUS 10841 GEORGE 6530 TEL:27824402763				SIMMENTALER
Birth Date: 17/09/2021	Simdex: ,	Star:	Reg. Status: REG	FEMALE/VROULIK
Age: 25 months	Days last calved:	ICP:	Inspection Date: 18/10/2022	Reg. No: 103591343
Herdbook: SP	Calvings:			
Horn: Polled	Calving dates:			

SIRE / VAAR:	<ul style="list-style-type: none"> KS1125 KYKSIM PETKA Scurred BMB1386 BOTHASIM PETKA Polled ACM1036 MILAGRO SANTJIE 1036 Polled BMB169 BOTHASIM PETKA Polled UG056 SALERIKA MENTOR Polled CE0951 SIMLEE MONSA * Horned CE06133 SIMLEE SALRI 	DAM / MOER:	<ul style="list-style-type: none"> E078 ERICO EKSELARO Polled DJA1049 ELLI'S OPIUM Polled CE0444 SIMLEE BARONIE ** Polled BMB1582 BOTHASIM BRENDA Horned Simdex: 72 Calving dates: 23/08/2022 17/09/2021 05/02/2020(Ab) ICP: 488 22/08/2018 CMO0273 RU-DEV STAAL ACM0930 MILAGRO BEATE 0930 Horned MCS0243 CONGOSIM BEATE 2DE
---------------------	--	--------------------	---

September 2023 South African Simmentaler BREEDPLAN										Simmentaler SA-- www.simmentaler.org									
2023	CED	CEM	BW	200	400	600	MCW	MILK	SC	DC	EMA	Rib	Rump	IMF%	RBV%	NFIP	SBI (R)	SPI (R)	
EBV	-1.2	--	+2.2	+16	+23	+29	+32	+4	--	--	--	--	--	--	--	--	--	--	
ACC	30%	--	49%	38%	36%	36%	35%	28%	--	--	--	--	--	--	--	--	--	--	
BREED	+0.3	+0.6	+1.6	+17	+27	+33	+35	+5	+0.3	-0.7	+0.3	+0.0	+0.1	+0.1	+0.2	-0.03	+481	+470	

Traits observed: CE

Seller's remarks / Verkoper se kommentaar:

R _____

LOT NR 33				
Verkoper	Beskrywing	Aantal	Koper	Prys
Kyksim Simmentalers	Simmentaler Koei & Kalf Kommerisieël	2+2		

*BMB20 28 & BMB20 1 (met 1 bulkalf en 1 verskalf)

LOT NR 34				
Verkoper	Beskrywing	Aantal	Koper	Prys
Kyksim Simmentalers	Simmentaler Koei & Kalf Kommerisieël	2+2		

*BMB18 27 & J19 4 (met 1 bulkalf en 1 verskalf)

LOT NR 35				
Verkoper	Beskrywing	Aantal	Koper	Prys
Kyksim Simmentalers	Simmentaler Koei Kommerisieël	1		

*BMB 16104

LOT NR 36				
Verkoper	Beskrywing	Aantal	Koper	Prys
Mount Pleasant Jerseys	Jersey Vers Dragtig Kommerisieël	4		

*5.5 maande dragtig

LOT NR 36A				
Verkoper	Beskrywing	Aantal	Koper	Prys
Mount Pleasant Jerseys	Jersey Vers Dragtig Kommerisieël	3		

*35-45 dae dragtig

LOT NR 37				
Verkoper	Beskrywing	Aantal	Koper	Prys
Mount Pleasant Jerseys	Jersey Vers Oop Kommerisieël	3		

*loop by bul

LOT NR 38				
Verkoper	Beskrywing	Aantal	Koper	Prys
B Botha	Rooi Angus Vroulik Dragtig / Oop Kommersieël	5		

*4 is 30 - 45 dae dragtig, oop vers is reeds gedek, dragtigheid sal bevestig word op dag van veiling

LOT NR 39				
Verkoper	Beskrywing	Aantal	Koper	Prys
Kykso	Simmentaler Koei Dragtig Kommersieël	1		

*MS 17 285

*5 maande dragtig van MS12 351

LOT NR 40				
Verkoper	Beskrywing	Aantal	Koper	Prys
Kykso	Simmentaler Vers Oop Kommersieël	2		

*MS 220 & MS 217

LOT NR 41				
Verkoper	Beskrywing	Aantal	Koper	Prys
Kykso	Simmentaler Vers Oop Kommersieël	4		

*MS 235, MS 267, MS 253, MS 243

LOT NR 42				
Verkoper	Beskrywing	Aantal	Koper	Prys
Kykso	Simmentaler Vers Oop Kommersieël	5		

*MS 265, MS 237, MS 263, MS 242, MS 240

LOT NR 43				
Verkoper	Beskrywing	Aantal	Koper	Prys
Kykso	Simmentaler Vers Dragtig Kommersieël	4		

*MS 239, MS 254, MS 241, MS 256

*2.5 maande dragtig van MS12 351

LOT NR 44				
Verkoper	Beskrywing	Aantal	Koper	Prys
Kykso	Simmentaler Vers Kommersieël	1		

*MS17266

*6 maande dragtig van MS12 351

LOT NR 45				
Verkoper	Beskrywing	Aantal	Koper	Prys
EP & AG Boerdery	Bonsmara Vers Dragtig Kommersieël	4		

*6.5 - 8 maande dragtig

LOT NR 46				
Verkoper	Beskrywing	Aantal	Koper	Prys
EP & AG Boerdery	Bonsmara Vers Dragtig of met kalf Kommersieël	4		

LOT NR 47				
Verkoper	Beskrywing	Aantal	Koper	Prys
EP & AG Boerdery	Bonsmara Vers Dekgereed Kommersieël	4		

LOT NR 48				
Verkoper	Beskrywing	Aantal	Koper	Prys
EP & AG Boerdery	Bonsmara Vers Dekgereed Kommersieël	4		

LOT NR 49				
Verkoper	Beskrywing	Aantal	Koper	Prys
EP & AG Boerdery	Bonsmara Vers Dekgereed Kommerseël	4		

LOT NR 50				
Verkoper	Beskrywing	Aantal	Koper	Prys
EP & AG Boerdery	Bonsmara Vers Dekgereed Kommerseël	4		

LOT NR 51				
Verkoper	Beskrywing	Aantal	Koper	Prys
Karoozicht	Brahman Koei & Kalf Kommerseël	3+3		

LOT NR 51A				
Verkoper	Beskrywing	Aantal	Koper	Prys
Karoozicht	Brahman Jong Koei kommerseel	2		

LOT NR 52				
Verkoper	Beskrywing	Aantal	Koper	Prys
Karoozicht	Brahman Vers Kommerseël	5		

*by bul geloop

LOT NR 53				
Verkoper	Beskrywing	Aantal	Koper	Prys
Karoozicht	Brahman Vers Kommerseël	4		

*by bul geloop

LOT NR 54				
Verkoper	Beskrywing	Aantal	Koper	Prys
Karoozicht	Brahman Vers Kommerseël	4		

*by bul geloop

LOT NR 55				
Verkoper	Beskrywing	Aantal	Koper	Prys
Karoozicht	Brahman Vers (klein)	1		



HALFWAY TOYOTA GEORGE

Interas veiling spesiale aanbieding

Hilux Xtra Cab 2.4 GD-6 Raider

Lys Prys R553200.00

Veiling Prys R497800.00





Halfway Toyota George

Wayne 074 502 7928





Emil Pretorius 083 320 7595
Keith Visagie 082 559 4843



NOTAS

A series of horizontal dotted lines for writing notes.

NOTAS

A series of horizontal dotted lines for writing notes.

BKB



Dankie vir u teenwoordigheid.

Thank you for your support.

VOORTREFLIKE DIENS

By BKB besef ons die belangrikheid van vertroue. 'n Vertroue dat die reën sal val en die grond 'n opbrengs sal lewer aan diegene wat dit bewerk. Ons weet vertroue kan nie gekoop word nie, maar word algaande verdien deur ons optrede en toewyding aan jou, in goeie en slegte tye. Ons is trots op die verhoudings wat ons oor geslagte met kliënte bou, almal gegrond op integriteit en gebind met 'n kyk in die oë en 'n stewige handdruk.

INTEGRITEIT

VOORTREFLIKE DIENS | ENTREPRENEURSKAP | VERDIENSTE | WERKNEMERS | OMGEWING

www.bkb.co.za

BKB

Die Betroubare Tuiste van Landbou

Laai gerus 'n gratis QR
toep af om te skandeer

