

AMPTELIKE VEILINGSKATALOGUS VIR /
OFFICIAL AUCTION CATALOGUE FOR

PINNACLE MEATMASTER GROUP

27 October 2023

All Pedigree- and Performance Data is as recorded on LOGIX on 12 October 2023



LOT 1 (M)



COLLETT FARMING CC

Venterstad, Eastern Cape
0814890198
crc@collettgroup.com



CC 220197

Herd Book	SP
Birth date	2022-04-26
Age	1.5 years
Inbreeding	6.43%
Birth Stat.	1
Progeny	None

CC 190358

Parentage Sire Dam

DNA
Genomic

CC 190631
AFL 19 | ILP 354 | EPI 99
Lambd 3 | Lams 3 | Weaned 3

CC 160592

CC 170507
AFL 12 | ILP 365 | EPI 124
Lambd 5 | Lams 6 | Weaned 6

CC 170452

CC 180564
AFL 11.9 | ILP 361 | EPI 130
Lambd 4 | Lams 6 | Weaned 6

CC 150018

CC 150530
AFL 12.2 | ILP 316 | EPI -
Lambd 4 | Lams 5 | Weaned 5

CC 150431

CC 140155
AFL 14.7 | ILP 368 | EPI 84
Lambd 3 | Lams 3 | Weaned 3

CC 140287

CC 130347
AFL - | ILP - | EPI 132
Lambd 7 | Lams 10 | Weaned 8

CC 150407

CC 130197
AFL 12.7 | ILP 364 | EPI 118
Lambd 5 | Lams 7 | Weaned 7

Growth			Reproduction			
Wn. Dir.	Wean Mat.	Post-Wn.	NLW	TWW	AFL	ILP
105	95	105	97	97	110	83
64%	43%	65%	35%	35%	34%	31%



EBV Analysis 2023-10-04

Logix Merit Index	100
Growth Index	103
Reproduction Index	97

SELLER REMARKS:

LOT 2 (M)



MEDALLION MEATMASTER STOET

Sutherland, Western Cape
0835562828
arvdm@sun.ac.za



MM 210280

Herd Book	SP
Birth date	2021-10-23
Age	2 years
Inbreeding	4.55%
Birth Stat.	1
Progeny	None

MM 190076

Parentage Sire Dam

DNA
Genomic

MM 200092
AFL 11.6 | ILP - | EPI 98
Lambd 1 | Lams 1 | Weaned 1

MM 180079

MM 170125
AFL 26.6 | ILP 411 | EPI 106
Lambd 4 | Lams 4 | Weaned 4

MM 180032

MM 170177
AFL 15.7 | ILP 379 | EPI 107
Lambd 4 | Lams 4 | Weaned 4

CC 160164

MM 110011
AFL 23.9 | ILP 452 | EPI -
Lambd 8 | Lams 9 | Weaned 9

MM 140108

MM 110004
AFL 24.6 | ILP 436 | EPI 103
Lambd 4 | Lams 6 | Weaned 6

CC 150407

MM 110026
AFL 12.4 | ILP 402 | EPI 111
Lambd 6 | Lams 8 | Weaned 7

MM 140096

MM 150097
AFL 16.4 | ILP 539 | EPI 119
Lambd 4 | Lams 7 | Weaned 7

Growth			Reproduction			
Wn. Dir.	Wean Mat.	Post-Wn.	NLW	TWW	AFL	ILP
108	110	109	92	92	98	89
60%	35%	63%	28%	28%	27%	25%



EBV Analysis 2023-10-04

Logix Merit Index	102
Growth Index	110
Reproduction Index	102

SELLER REMARKS:

LOT 4 (M)



COLLETT FARMING CC

Venterstad, Eastern Cape
0814890198
crc@collettgroup.com



CC 220253

Herd Book	SP
Birth date	2022-05-15
Age	1.4 years
Inbreeding	5.2%
Birth Stat.	1
Progeny	None

CC 200075

Parentage Sire Dam

DNA
Genomic

CC 210051
AFL 13.3 | ILP 328 | EPI 109
Lambd 2 | Lams 2 | Weaned 2

CC 170528

CC 160093
AFL 10.5 | ILP 324 | EPI 161
Lambd 8 | Lams 15 | Weaned 13

CC 190866

CC 180041
AFL 12.9 | ILP 358 | EPI 107
Lambd 4 | Lams 6 | Weaned 5

CC 160226

CC 160391
AFL 12 | ILP 363 | EPI -
Lambd 3 | Lams 3 | Weaned 3

CRC 120174

CRC 120014
AFL - | ILP - | EPI 92
Lambd 3 | Lams 4 | Weaned 4

CC 160592

CC 170065
AFL 14.2 | ILP 321 | EPI 148
Lambd 6 | Lams 8 | Weaned 7

CC 150431

CC 160349
AFL 11.9 | ILP 340 | EPI 146
Lambd 6 | Lams 11 | Weaned 10

Growth			Reproduction			
Wn. Dir.	Wean Mat.	Post-Wn.	NLW	TWW	AFL	ILP
125	107	125	121	121	118	93
63%	42%	65%	34%	34%	33%	31%



EBV Analysis 2023-10-04

Logix Merit Index	133
Growth Index	122
Reproduction Index	127

SELLER REMARKS:

LOT 5 (M)

CC 200900



Kuddeboek	A
Geb. dtm	2020-05-01
Oud.	3.5 jaar
Inteling	2.58%
Geb. Status	1

Nageslag	
In Kudde	15
Totaal	15
Kuddes Gebruik	1

COLLETT FARMING CC

Venterstad, Eastern Cape
0814890198
crc@collettgroup.com

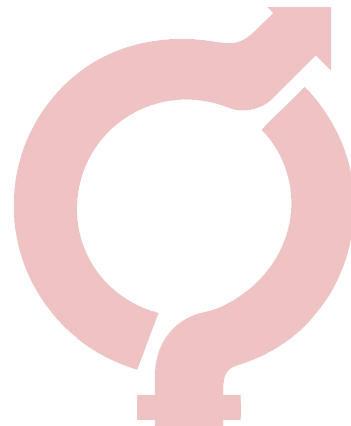

Groeï			Reproduksie			
Spn. Dir.	Spn. Mat.	Na-Spn.	GLS	TWW	OEL	ILP
87	92	86	108	108	96	-
58%	5%	60%	5%	5%	10%	-%



EBV Analise 2023-10-04

Logix Meriete Indeks	-
Groeï Indeks	87
Reproduksie Indeks	-

VERKOPER OPMERKINGS:

LOT 6 (M)

CC 220270

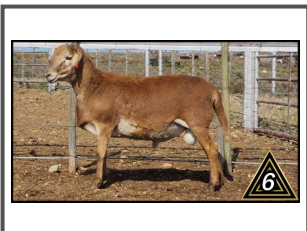

Kuddeboek	SP
Geb. dtm	2022-05-31
Oud.	1.4 jaar
Inteling	5.88%
Geb. Status	1

Nageslag	
Geen	

COLLETT FARMING CC

Venterstad, Eastern Cape
0814890198
crc@collettgroup.com

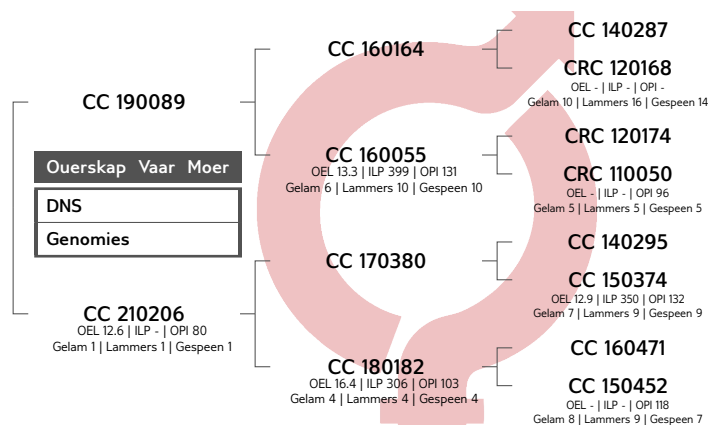

Groeï			Reproduksie			
Spn. Dir.	Spn. Mat.	Na-Spn.	GLS	TWW	OEL	ILP
101	108	106	105	105	99	87
61%	43%	64%	37%	37%	37%	33%



EBV Analise 2023-10-04

Logix Meriete Indeks	104
Groeï Indeks	104
Reproduksie Indeks	107

VERKOPER OPMERKINGS:

LOT 7 (M)

MM 210146



Kuddeboek	SP
Geb. dtm	2021-10-04
Oud.	2.1 jaar
Inteling	5.89%
Geb. Status	1

Nageslag	
Geen	

MEDALLION MEATMASTER STOET

Sutherland, Western Cape
0835562828
arvdm@sun.ac.za

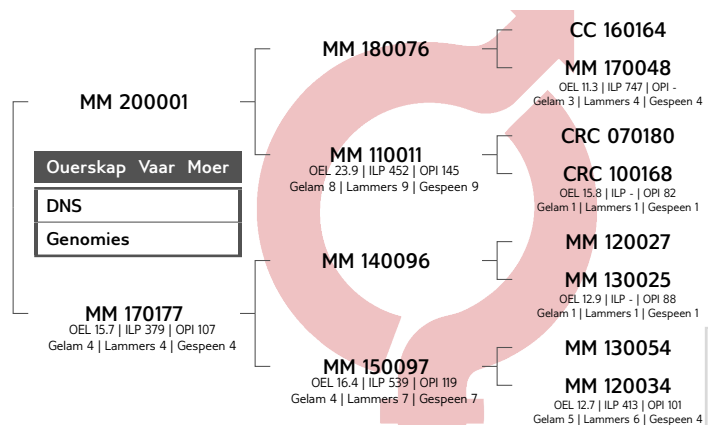

Groeï			Reproduksie			
Spn. Dir.	Spn. Mat.	Na-Spn.	GLS	TWW	OEL	ILP
110	117	110	94	94	94	94
59%	41%	60%	33%	33%	29%	30%



EBV Analise 2023-10-04

Logix Meriete Indeks	107
Groeï Indeks	113
Reproduksie Indeks	106

VERKOPER OPMERKINGS:

LOT 8 (M)

MM 200072



Herd Book	SP
Birth date	2020-11-04
Age	3 years
Inbreeding	3.3%
Birth Stat.	1
Progeny	None

MEDALLION MEATMASTER STOET

Sutherland, Western Cape
0835562828
arvdm@sun.ac.za

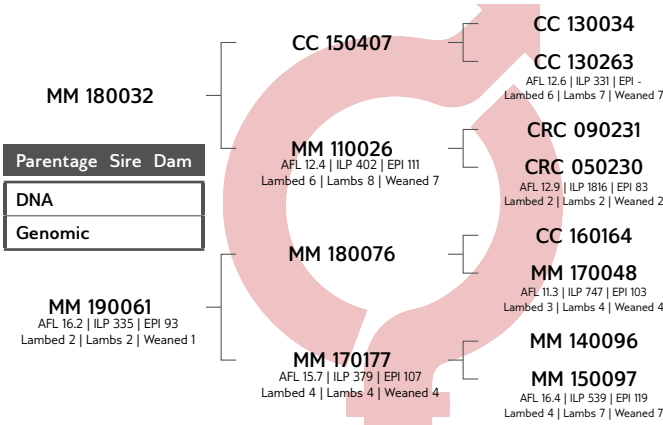

Growth			Reproduction			
Wn. Dir.	Wean Mat.	Post-Wn.	NLW	TWW	AFL	ILP
115	109	114	102	102	105	96
62%	42%	64%	35%	35%	34%	32%



EBV Analysis 2023-10-04

Logix Merit Index	115
Growth Index	115
Reproduction Index	111

SELLER REMARKS:

LOT 10 (M)

CC 210428



Herd Book	SP
Birth date	2021-09-02
Age	2.1 years
Inbreeding	4.87%
Birth Stat.	2
Progeny	None

COLLETT FARMING CC

Venterstad, Eastern Cape
0814890198
crc@collettgroup.com

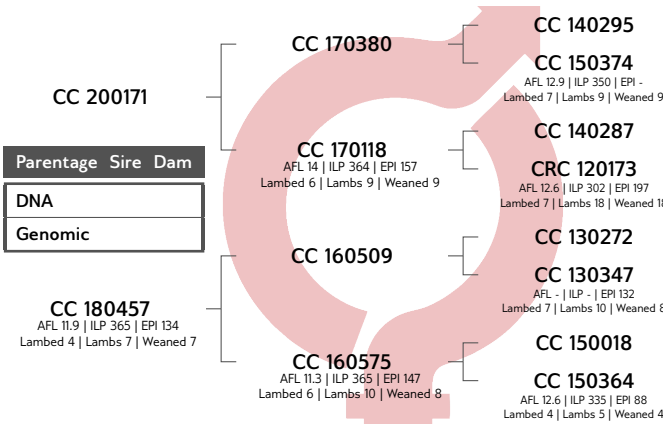

Growth			Reproduction			
Wn. Dir.	Wean Mat.	Post-Wn.	NLW	TWW	AFL	ILP
120	109	120	100	100	113	79
64%	48%	66%	40%	40%	37%	35%



EBV Analysis 2023-10-04

Logix Merit Index	115
Growth Index	119
Reproduction Index	111

SELLER REMARKS:

LOT 11 (M)

CC 220217



Herd Book	SP
Birth date	2022-05-01
Age	1.5 years
Inbreeding	4.91%
Birth Stat.	1
Progeny	None

COLLETT FARMING CC

Venterstad, Eastern Cape
0814890198
crc@collettgroup.com

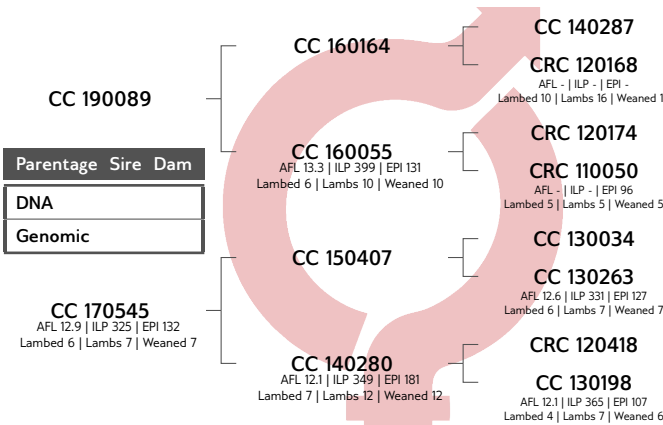

Growth			Reproduction			
Wn. Dir.	Wean Mat.	Post-Wn.	NLW	TWW	AFL	ILP
98	118	101	107	107	106	82
64%	48%	66%	41%	41%	38%	36%



EBV Analysis 2023-10-04

Logix Merit Index	110
Growth Index	104
Reproduction Index	116

SELLER REMARKS:

LOT 12 (M)

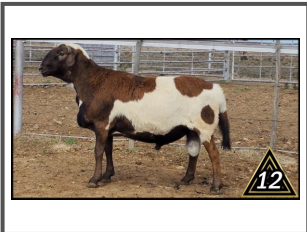

COLLETT FARMING CC

Venterstad, Eastern Cape
0814890198
crc@collettgroup.com



CC 220207

Kuddeboek	SP
Geb. dtm	2022-04-28
Oud.	1.5 jaar
Inteling	5.71%
Geb. Status	2
Nageslag	
Geen	

CC 190145

Ouerskap Vaar Moer

DNS

Genomies

CC 210203
OEL 11.5 | ILP 327 | OPI 136
Gelam 2 | Lammers 4 | Gespeen 4

CC 170390

CC 160021
OEL 13.9 | ILP 363 | OPI 119
Gelam 6 | Lammers 7 | Gespeen 7

CC 190576

CC 160566
OEL 12.6 | ILP 329 | OPI 116
Gelam 6 | Lammers 6 | Gespeen 5

CC 150407

CC 150074
OEL 18.9 | ILP 355 | OPI -
Gelam 2 | Lammers 3 | Gespeen 3

CC 130272

CRC 100029
OEL - | ILP - | OPI 127
Gelam 6 | Lammers 6 | Gespeen 6

CC 160164

CC 140076
OEL 17.2 | ILP 364 | OPI 133
Gelam 5 | Lammers 8 | Gespeen 8

CC 150018

CC 150536
OEL - | ILP - | OPI 129
Gelam 8 | Lammers 9 | Gespeen 8

Groeï			Reproduksie			
Spn. Dir.	Spn. Mat.	Na-Spn.	GLS	TWW	OEL	ILP
116	115	118	104	104	101	87
64%	49%	66%	40%	40%	40%	38%



EBV Analise 2023-10-04

Logix Meriete Indeks **117**

Groeï Indeks **118**

Reproduksie Indeks **115**

VERKOPER OPMERKINGS:

LOT 13 (M)



COLLETT FARMING CC

Venterstad, Eastern Cape
0814890198
crc@collettgroup.com



CC 220117

Kuddeboek	SP
Geb. dtm	2022-04-12
Oud.	1.5 jaar
Inteling	4.7%
Geb. Status	1
Nageslag	
Geen	

CC 200021

Ouerskap Vaar Moer

DNS

Genomies

CC 200005
OEL 13.5 | ILP 330 | OPI 99
Gelam 2 | Lammers 2 | Gespeen 2

CC 170528

CC 160539
OEL 12.6 | ILP 328 | OPI 125
Gelam 6 | Lammers 7 | Gespeen 6

CC 170390

CC 160092
OEL 13.9 | ILP 360 | OPI 94
Gelam 4 | Lammers 5 | Gespeen 4

CC 160226

CC 160391
OEL 12 | ILP 363 | OPI -
Gelam 3 | Lammers 3 | Gespeen 3

CC 150068

CC 150509
OEL 12.1 | ILP 365 | OPI 103
Gelam 4 | Lammers 7 | Gespeen 6

CC 150407

CC 150074
OEL 18.9 | ILP 355 | OPI 91
Gelam 2 | Lammers 3 | Gespeen 3

CRC 090340

CRC 110019
OEL - | ILP - | OPI 122
Gelam 8 | Lammers 8 | Gespeen 7

Groeï			Reproduksie			
Spn. Dir.	Spn. Mat.	Na-Spn.	GLS	TWW	OEL	ILP
109	112	115	86	86	98	90
61%	41%	64%	34%	34%	34%	33%



EBV Analise 2023-10-04

Logix Meriete Indeks **99**

Groeï Indeks **112**

Reproduksie Indeks **99**

VERKOPER OPMERKINGS:

LOT 14 (M)



COLLETT FARMING CC

Venterstad, Eastern Cape
0814890198
crc@collettgroup.com



CC 220153

Kuddeboek	SP
Geb. dtm	2022-04-18
Oud.	1.5 jaar
Inteling	5.63%
Geb. Status	2
Nageslag	
Geen	

CC 190576

Ouerskap Vaar Moer

DNS

Genomies

CC 200122
OEL 12.4 | ILP 362 | OPI 96
Gelam 2 | Lammers 4 | Gespeen 2

CC 160164

CC 140076
OEL 17.2 | ILP 364 | OPI 133
Gelam 5 | Lammers 8 | Gespeen 8

CC 170380

CC 170149
OEL 11.9 | ILP 368 | OPI 154
Gelam 6 | Lammers 8 | Gespeen 7

CC 140287

CRC 120168
OEL - | ILP - | OPI -
Gelam 10 | Lammers 16 | Gespeen 14

CRC 090340

CRC 100500
OEL - | ILP - | OPI 115
Gelam 5 | Lammers 6 | Gespeen 6

CC 140295

CC 150374
OEL 12.9 | ILP 350 | OPI 132
Gelam 7 | Lammers 9 | Gespeen 9

CC 150018

CC 150113
OEL 12.7 | ILP 358 | OPI 100
Gelam 4 | Lammers 5 | Gespeen 5

Groeï			Reproduksie			
Spn. Dir.	Spn. Mat.	Na-Spn.	GLS	TWW	OEL	ILP
117	100	120	111	111	111	81
64%	48%	66%	40%	40%	40%	35%



EBV Analise 2023-10-04

Logix Meriete Indeks **116**

Groeï Indeks **115**

Reproduksie Indeks **111**

VERKOPER OPMERKINGS:

LOT 15 (M)

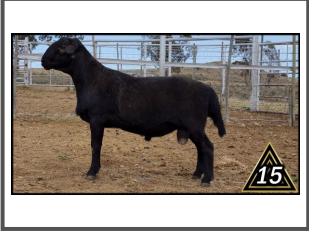

COLLETT FARMING CC
 Venterstad, Eastern Cape
 0814890198
 crc@collettgroup.com

CC 220220

Herd Book	SP
Birth date	2022-05-01
Age	1.5 years
Inbreeding	4.94%
Birth Stat.	1
Progeny	None

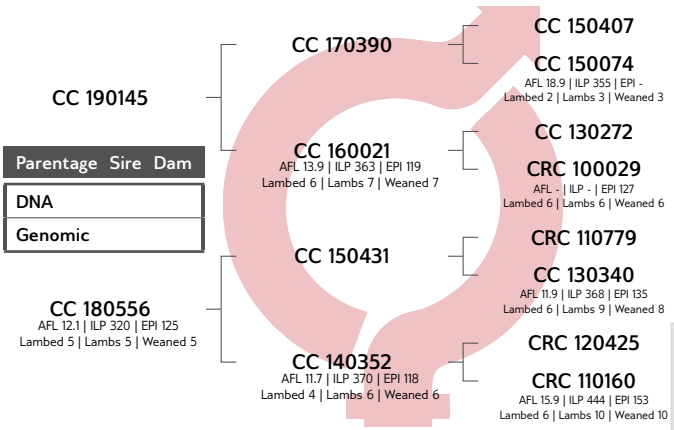

Growth			Reproduction			
Wn. Dir.	Wean Mat.	Post-Wn.	NLW	TWW	AFL	ILP
99	104	98	90	90	110	93
65%	51%	67%	43%	43%	42%	40%



EBV Analysis 2023-10-04

Logix Merit Index	97
Growth Index	100
Reproduction Index	98

SELLER REMARKS:

LOT 16 (M)



COLLETT FARMING CC
 Venterstad, Eastern Cape
 0814890198
 crc@collettgroup.com

CC 220096

Herd Book	SP
Birth date	2022-04-07
Age	1.6 years
Inbreeding	4.91%
Birth Stat.	2
Progeny	None

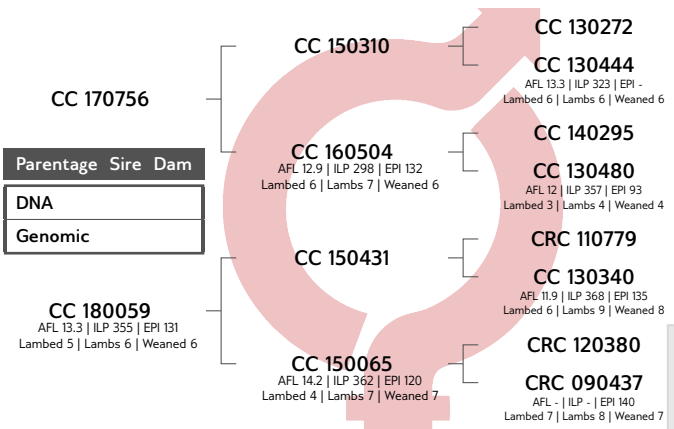

Growth			Reproduction			
Wn. Dir.	Wean Mat.	Post-Wn.	NLW	TWW	AFL	ILP
116	100	113	98	98	91	94
66%	53%	67%	44%	44%	43%	39%



EBV Analysis 2023-10-04

Logix Merit Index	106
Growth Index	112
Reproduction Index	98

SELLER REMARKS:

LOT 17 (M)



COLLETT FARMING CC
 Venterstad, Eastern Cape
 0814890198
 crc@collettgroup.com

CC 220092

Herd Book	SP
Birth date	2022-04-07
Age	1.6 years
Inbreeding	4.78%
Birth Stat.	2
Progeny	None

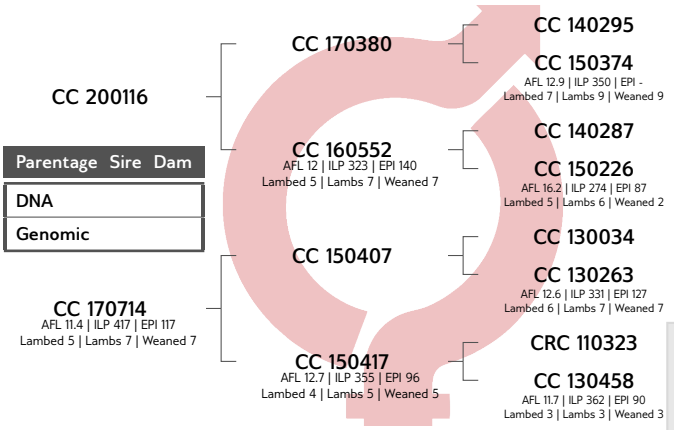

Growth			Reproduction			
Wn. Dir.	Wean Mat.	Post-Wn.	NLW	TWW	AFL	ILP
108	100	108	94	94	98	82
63%	45%	65%	38%	38%	36%	33%



EBV Analysis 2023-10-04

Logix Merit Index	98
Growth Index	107
Reproduction Index	96

SELLER REMARKS:

LOT 18 (M)



COLLETT FARMING CC
 Venterstad, Eastern Cape
 0814890198
 crc@collettgroup.com



CC 220287

Kuddeboek	A
Geb. dtm	2022-04-10
Oud.	1.6 jaar
Inteling	%
Geb. Status	1
Nageslag	
Geen	

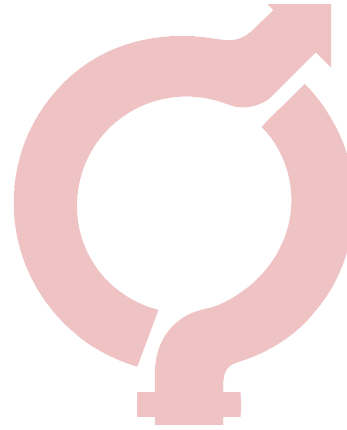

Groeï			Reproduksie			
Spn. Dir.	Spn. Mat.	Na-Spn.	GLS	TWW	OEL	ILP
-	-	-	-	-	-	-
-%	-%	-%	-%	-%	-%	-%



EBV Analise 2023-10-04

Logix Meriete Indeks	-
Groeï Indeks	-
Reproduksie Indeks	-

VERKOPER OPMERKINGS:

LOT 19 (M)

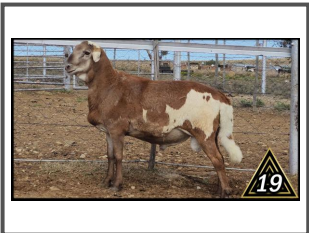

COLLETT FARMING CC
 Venterstad, Eastern Cape
 0814890198
 crc@collettgroup.com



CC 220281

Kuddeboek	A
Geb. dtm	2022-04-10
Oud.	1.6 jaar
Inteling	%
Geb. Status	1
Nageslag	
Geen	

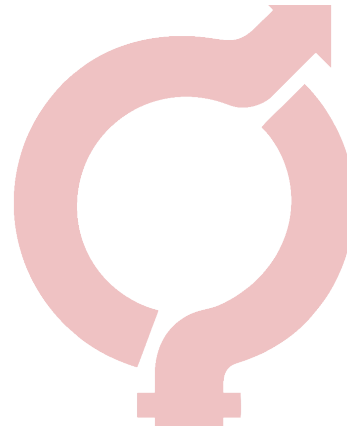

Groeï			Reproduksie			
Spn. Dir.	Spn. Mat.	Na-Spn.	GLS	TWW	OEL	ILP
-	-	-	-	-	-	-
-%	-%	-%	-%	-%	-%	-%



EBV Analise 2023-10-04

Logix Meriete Indeks	-
Groeï Indeks	-
Reproduksie Indeks	-

VERKOPER OPMERKINGS:

LOT 20 (M)

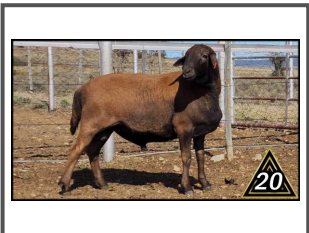

COLLETT FARMING CC
 Venterstad, Eastern Cape
 0814890198
 crc@collettgroup.com



CC 220256

Kuddeboek	SP
Geb. dtm	2022-05-24
Oud.	1.4 jaar
Inteling	6.55%
Geb. Status	1
Nageslag	
Geen	

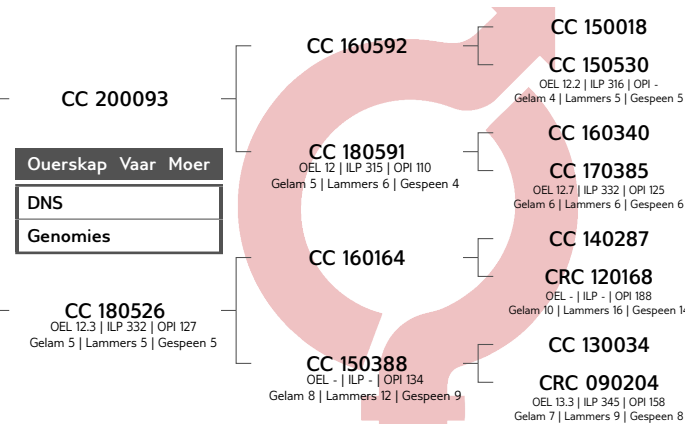

Groeï			Reproduksie			
Spn. Dir.	Spn. Mat.	Na-Spn.	GLS	TWW	OEL	ILP
115	102	115	98	98	114	90
62%	45%	65%	38%	38%	37%	33%



EBV Analise 2023-10-04

Logix Meriete Indeks	110
Groeï Indeks	113
Reproduksie Indeks	106

VERKOPER OPMERKINGS:

LOT 21 (M)

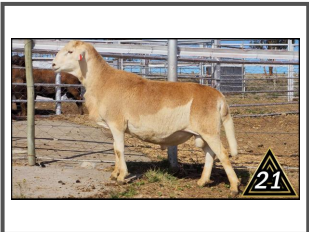

COLLETT FARMING CC
 Venterstad, Eastern Cape
 0814890198
 crc@collettgroup.com

CC 220098



Herd Book	SP
Birth date	2022-04-07
Age	1.6 years
Inbreeding	6.19%
Birth Stat.	2
Progeny	None

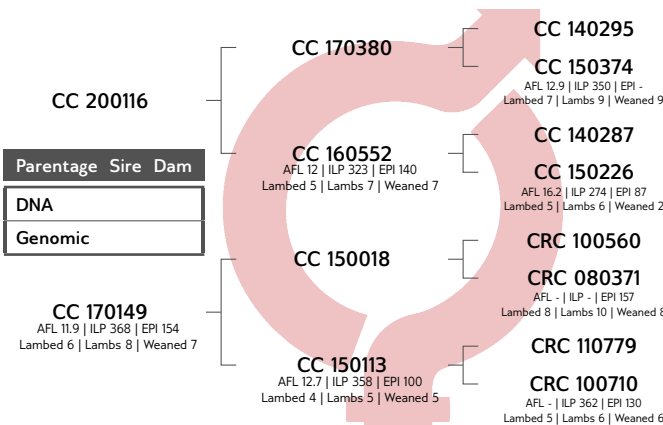

Growth			Reproduction			
Wn. Dir.	Wean Mat.	Post-Wn.	NLW	TWW	AFL	ILP
100	93	103	100	100	104	85
62%	45%	64%	38%	38%	34%	34%



EBV Analysis 2023-10-04

Logix Merit Index	95
Growth Index	98
Reproduction Index	95

SELLER REMARKS:

LOT 22 (M)



COLLETT FARMING CC
 Venterstad, Eastern Cape
 0814890198
 crc@collettgroup.com

CC 220294



Herd Book	A
Birth date	2022-04-18
Age	1.5 years
Inbreeding	%
Birth Stat.	1
Progeny	None

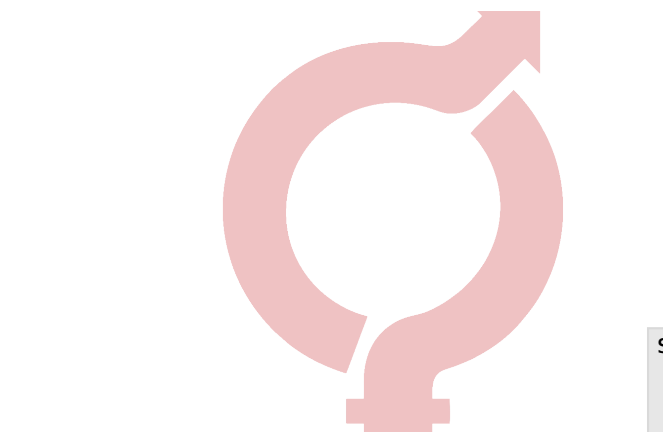

Growth			Reproduction			
Wn. Dir.	Wean Mat.	Post-Wn.	NLW	TWW	AFL	ILP
-	-	-	-	-	-	-
-%	-%	-%	-%	-%	-%	-%



EBV Analysis 2023-10-04

Logix Merit Index	-
Growth Index	-
Reproduction Index	-

SELLER REMARKS:

LOT 23 (M)

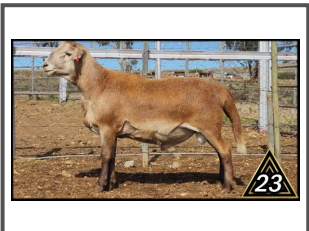

COLLETT FARMING CC
 Venterstad, Eastern Cape
 0814890198
 crc@collettgroup.com

CC 220130



Herd Book	SP
Birth date	2022-04-12
Age	1.5 years
Inbreeding	4.8%
Birth Stat.	1
Progeny	None

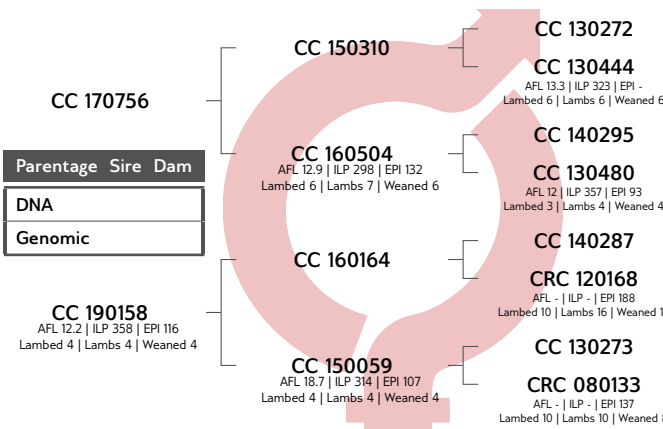

Growth			Reproduction			
Wn. Dir.	Wean Mat.	Post-Wn.	NLW	TWW	AFL	ILP
113	107	112	83	83	94	87
66%	52%	67%	44%	44%	43%	41%



EBV Analysis 2023-10-04

Logix Merit Index	97
Growth Index	112
Reproduction Index	93

SELLER REMARKS:

LOT 24 (M)

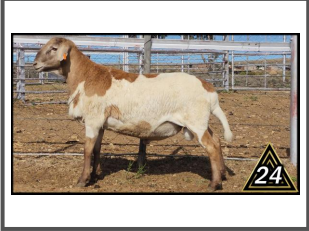

COLLETT FARMING CC
 Venterstad, Eastern Cape
 0814890198
 crc@collettgroup.com

CC 220295

Kuddeboek	A
Geb. dtm	2022-04-18
Oud.	1.5 jaar
Inteling	%
Geb. Status	1
Nageslag	
Geen	

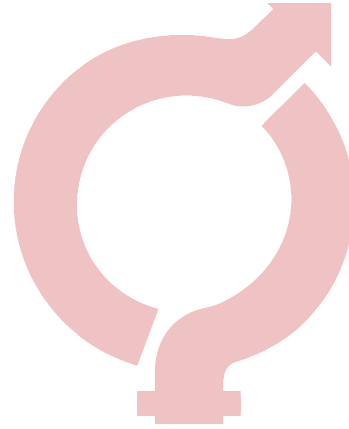

Groeï			Reproduksie			
Spn. Dir.	Spn. Mat.	Na-Spn.	GLS	TWW	OEL	ILP
-	-	-	-	-	-	-
-%	-%	-%	-%	-%	-%	-%



EBV Analise 2023-10-04

Logix Meriete Indeks	-
Groeï Indeks	-
Reproduksie Indeks	-

VERKOPER OPMERKINGS:

LOT 25 (M)



COLLETT FARMING CC
 Venterstad, Eastern Cape
 0814890198
 crc@collettgroup.com

CC 220125

Kuddeboek	SP
Geb. dtm	2022-04-12
Oud.	1.5 jaar
Inteling	5.42%
Geb. Status	1
Nageslag	
Geen	

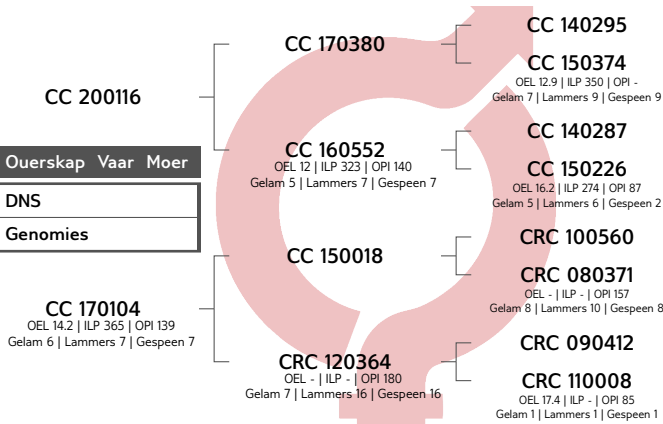

Groeï			Reproduksie			
Spn. Dir.	Spn. Mat.	Na-Spn.	GLS	TWW	OEL	ILP
106	95	107	97	97	93	83
63%	45%	65%	38%	38%	35%	34%



EBV Analise 2023-10-04

Logix Meriete Indeks	94
Groeï Indeks	104
Reproduksie Indeks	92

VERKOPER OPMERKINGS:

LOT 26 (M)

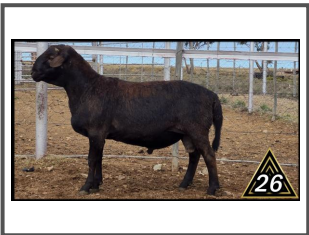

COLLETT FARMING CC
 Venterstad, Eastern Cape
 0814890198
 crc@collettgroup.com

CC 220033

Kuddeboek	SP
Geb. dtm	2022-04-03
Oud.	1.6 jaar
Inteling	6.67%
Geb. Status	1
Nageslag	
Geen	

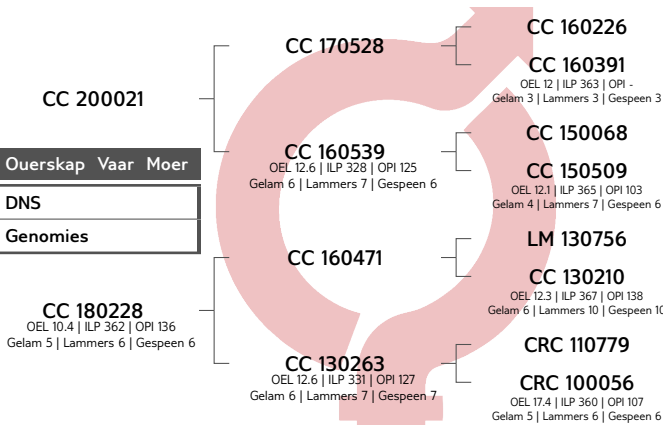

Groeï			Reproduksie			
Spn. Dir.	Spn. Mat.	Na-Spn.	GLS	TWW	OEL	ILP
101	113	110	91	91	96	91
63%	43%	64%	35%	35%	32%	32%



EBV Analise 2023-10-04

Logix Meriete Indeks	96
Groeï Indeks	107
Reproduksie Indeks	101

VERKOPER OPMERKINGS:

LOT 27 (M)

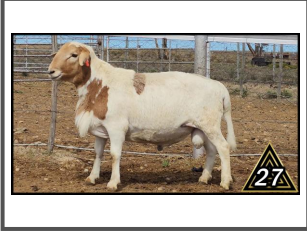

COLLETT FARMING CC

Venterstad, Eastern Cape
0814890198
crc@collettgroup.com



CC 220040

Herd Book	SP
Birth date	2022-04-03
Age	1.6 years
Inbreeding	5.81%
Birth Stat.	1
Progeny	None

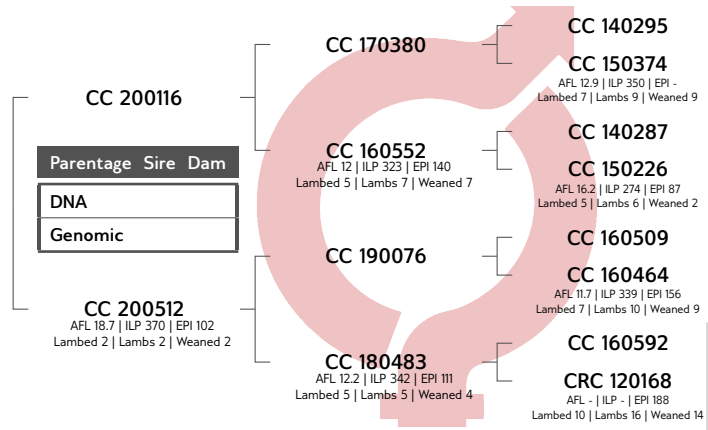

Growth			Reproduction			
Wn. Dir.	Wean Mat.	Post-Wn.	NLW	TWW	AFL	ILP
106	106	111	95	95	112	79
61%	41%	63%	34%	34%	33%	32%



EBV Analysis 2023-10-04

Logix Merit Index	102
Growth Index	108
Reproduction Index	103

SELLER REMARKS: