



D O R M E R K L U B

KIES SUKSES - DORMER DOEN DIE RES

17 Feb 24

11:00

POTCH



25 Ramme
35 Ooie
120 Komm
Ooie

Diaan 083 636 2314

Fanie 082 859 1867



dormer

MEERKAT
ONLINE AUCTIONS

Onder die beskerming van die Dormer Genootskap

SELECTION INDICES FOR DORMER

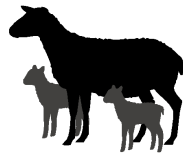

1 L♀ GIX Merit Index

A total merit index for the breed for selection of balanced, profitable animals in both growth and reproduction.

2 Growth Index

Selection for:

- Fast growth potential
- Good maternal ability
- Heavy lambs at weaning
- Early market-readiness

Total Weight Weaned (10)

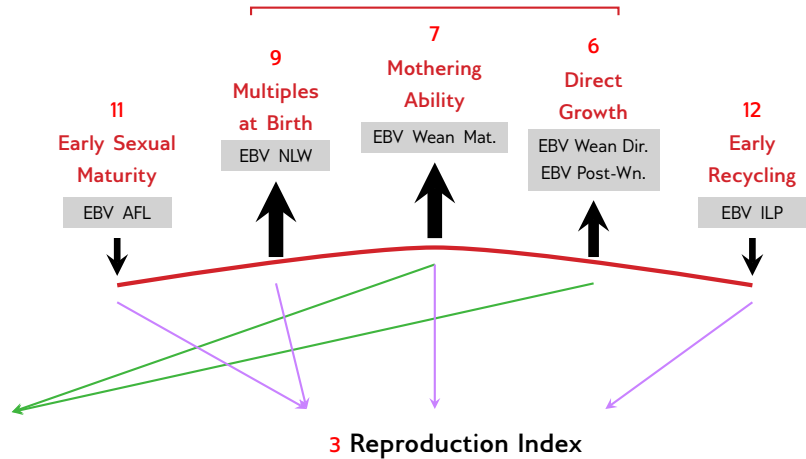

Selection for:

- Early sexual maturity
- Regular pregnancies
- Multiples at birth
- Good mothering ability
- Heavy lambs at weaning

GENETIC VALUES - BUILDING BLOCKS

Growth			Reproduction			
Wn. Dir.	Wean Mat.	Post-Wn.	NLW	TWW	AFL	ILP
108	99	102	115	102	134	110
64%	45%	51%	52%	45%	36%	40%
6	7	8	9	10	11	12

The Logix Selection Indices are compiled of specific genetic building blocks, as indicated in the selection index descriptions above. These genetic building blocks are indicated in the catalogue by their Breeding Value indices and accuracies.

LOT 1 (F)



RW 180082
RUSWATER EWE RW180082

Herd Book	SP	
Birth date	2018-09-04	
Age	5.5 years	
Inbreeding	5.31%	
Birth Stat.	1	
AFL	ILP	EPI
22.6m	301d	115
Lambled	5	
Lambs	9	
Weaned	8	

F.J. KRUGER
Potchefstroom, North West
0828591867
ruswater.kruger@gmail.com

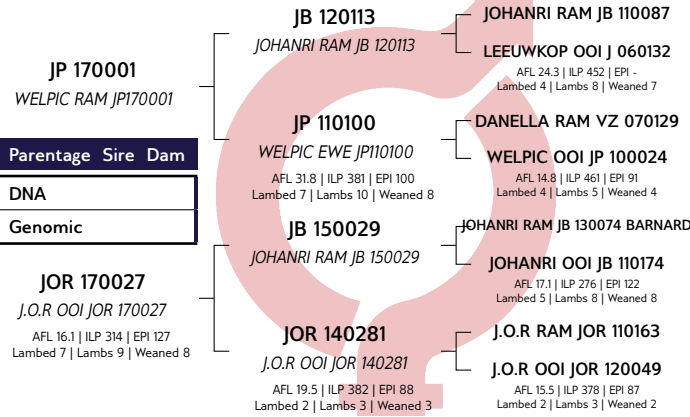

Growth			Reproduction			
Wn. Dir.	Wean Mat.	Post-Wn.	NLW	TWW	AFL	ILP
91	98	91	105	105	107	130
68%	70%	52%	55%	55%	46%	39%



Logix Merit Index	103
Growth Index	94
Reproduction Index	111

SELLER REMARKS: Loop by Ram JT21-438.

LOT 2 (F)



RW 190110
RUSWATER EWE RW190110

Herd Book	SP	
Birth date	2019-11-18	
Age	4.2 years	
Inbreeding	4%	
Birth Stat.	2	
AFL	ILP	EPI
21.2m	267d	127
Lambled	4	
Lambs	4	
Weaned	4	

F.J. KRUGER
Potchefstroom, North West
0828591867
ruswater.kruger@gmail.com

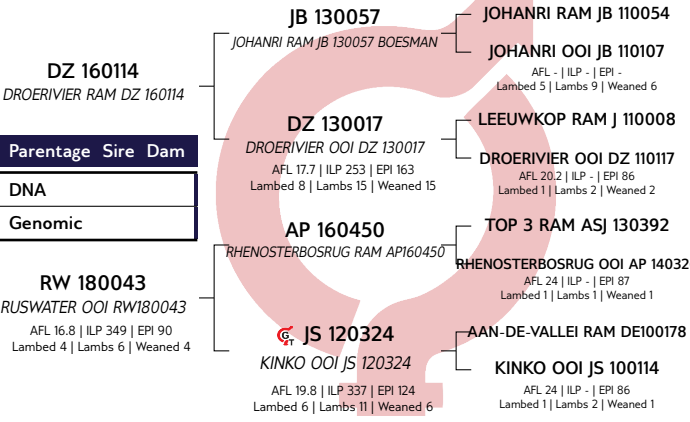

Growth			Reproduction			
Wn. Dir.	Wean Mat.	Post-Wn.	NLW	TWW	AFL	ILP
96	94	102	97	97	102	114
61%	62%	44%	50%	50%	34%	34%



Logix Merit Index	97
Growth Index	96
Reproduction Index	97

SELLER REMARKS: Loop by Ram JT21-438.

LOT 3 (F)



RW 200034
RUSWATER EWE RW200034

Herd Book	SP	
Birth date	2020-07-22	
Age	3.6 years	
Inbreeding	4.52%	
Birth Stat.	3	
AFL	ILP	EPI
17m	290d	121
Lambled	3	
Lambs	5	
Weaned	4	

F.J. KRUGER
Potchefstroom, North West
0828591867
ruswater.kruger@gmail.com

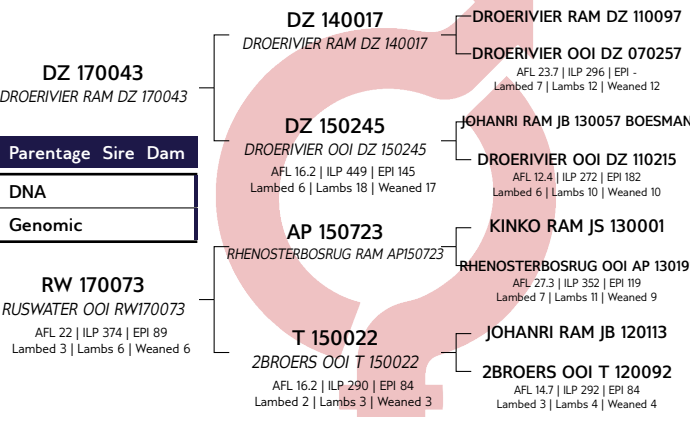

Growth			Reproduction			
Wn. Dir.	Wean Mat.	Post-Wn.	NLW	TWW	AFL	ILP
86	109	87	101	101	103	116
64%	62%	59%	49%	49%	45%	39%



Logix Merit Index	98
Growth Index	94
Reproduction Index	110

SELLER REMARKS: Dragtig - AP19-116, Verwagte Lam Datum 3 May 2024

LOT 4 (F)



RW 200052
RUSWATER EWE RW200052

Kuddeboek	SP	
Geb. dtm	2020-07-23	
Oud.	3.6 jaar	
Inteling	7.32%	
Geb. Status	2	
OEL	ILP	OPI
17.1m	286d	108
Gelam	3	
Lammers	5	
Gespeen	4	

F.J. KRUGER
Potchefstroom, North West
0828591867
ruswater.kruger@gmail.com

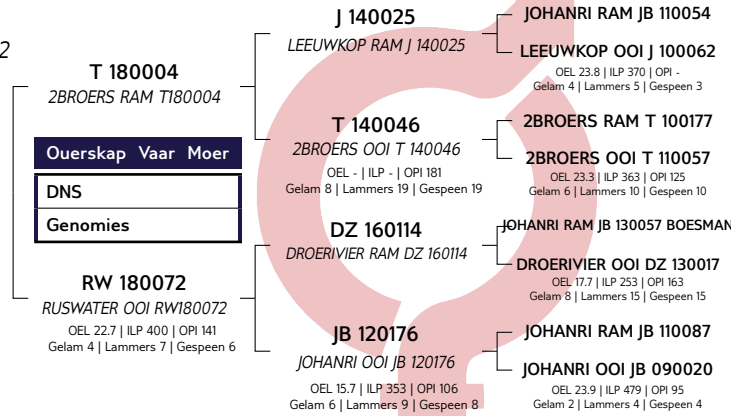

Groeï			Reproduksie			
Spn. Dir.	Spn. Mat.	Na-Spn.	GLS	TWW	OEL	ILP
87	103	82	110	110	94	114
64%	62%	59%	47%	47%	45%	37%



Logix Meriete Indeks	99
Groeï Indeks	92
Reproduksie Indeks	111

VERKOPER OPMERKINGS: Dragtig - JT21-438, Verwagte Lam Datum 3 May 2024

LOT 5 (F)



RW 200060
RUSWATER OOI RW200060

Kuddeboek	SP	
Geb. dtm	2020-07-23	
Oud.	3.6 jaar	
Inteling	4.64%	
Geb. Status	2	
OEL	ILP	OPI
16.9m	290d	114
Gelam	3	
Lammers	3	
Gespeen	3	

F.J. KRUGER
Potchefstroom, North West
0828591867
ruswater.kruger@gmail.com

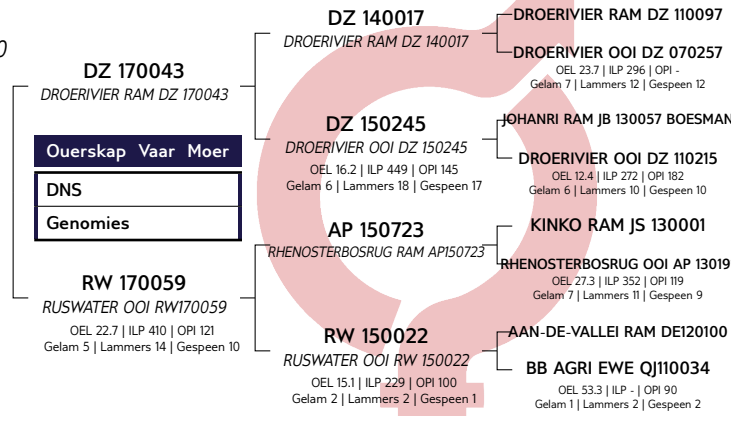

Groeï			Reproduksie			
Spn. Dir.	Spn. Mat.	Na-Spn.	GLS	TWW	OEL	ILP
86	104	87	114	114	103	110
64%	63%	60%	49%	49%	44%	38%



Logix Meriete Indeks	102
Groeï Indeks	91
Reproduksie Indeks	117

VERKOPER OPMERKINGS: Loop by Ram JT21-438

LOT 6 (F)



RW 200109
RUSWATER EWE RW200109

Kuddeboek	SP	
Geb. dtm	2020-07-27	
Oud.	3.6 jaar	
Inteling	4.55%	
Geb. Status	2	
OEL	ILP	OPI
23.8m	-	87
Gelam	1	
Lammers	1	
Gespeen	1	

F.J. KRUGER
Potchefstroom, North West
0828591867
ruswater.kruger@gmail.com

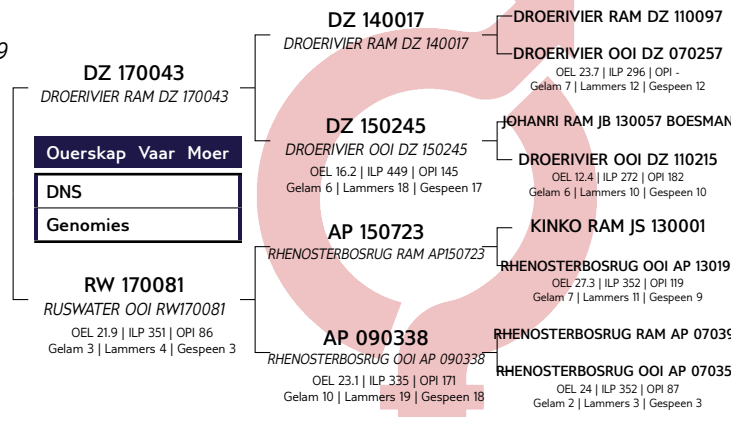

Groeï			Reproduksie			
Spn. Dir.	Spn. Mat.	Na-Spn.	GLS	TWW	OEL	ILP
81	92	83	104	104	109	117
62%	59%	58%	47%	47%	44%	36%



Logix Meriete Indeks	89
Groeï Indeks	80
Reproduksie Indeks	102

VERKOPER OPMERKINGS: Dragtig - AP19-116, Verwagte Lam Datum 3 May 2024

LOT 7 (F)



RW 210014
RUSWATER OOI RW 210014

Herd Book	SP	
Birth date	2021-05-18	
Age	2.8 years	
Inbreeding	5.26%	
Birth Stat.	1	
AFL	ILP	EPI
16.7m	-	91
Lambled	1	
Lambs	1	
Weaned	1	

F.J. KRUGER
Potchefstroom, North West
0828591867
ruswater.kruger@gmail.com

T 180004
2BROERS RAM T180004

Parentage Sire Dam
DNA
Genomic

RW 190062
RUSWATER EWE RW190062
AFL 22.2 | ILP 313 | EPI 103
Lambled 3 | Lambs 5 | Weaned 4

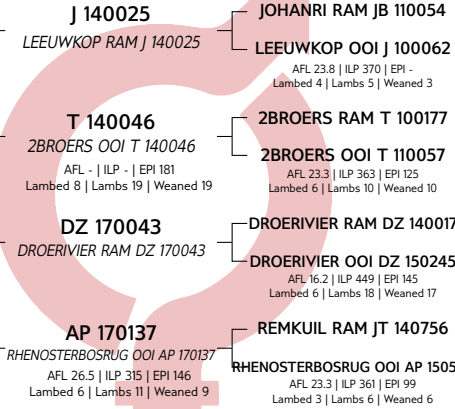

Growth			Reproduction			
Wn. Dir.	Wean Mat.	Post-Wn.	NLW	TWW	AFL	ILP
85	113	82	81	81	102	107
63%	59%	60%	47%	47%	46%	35%



EBV Analysis 2024-02-02

Logix Merit Index	87
Growth Index	95
Reproduction Index	93

SELLER REMARKS: Dragtig - AP19-116, Verwagte Lam Datum 3 May 2024. Met lam.

LOT 8 (F)



RW 210132
RUSWATER OOI RW 210132

Herd Book	SP	
Birth date	2021-08-16	
Age	2.5 years	
Inbreeding	4.21%	
Birth Stat.	1	
AFL	ILP	EPI
17.6m	-	97
Lambled	1	
Lambs	1	
Weaned	1	

F.J. KRUGER
Potchefstroom, North West
0828591867
ruswater.kruger@gmail.com

NB 190462
NOVA BARLETTA RAM NB190462

Parentage Sire Dam
DNA
Genomic

DE 170018
AAN-DE-VALLEI OOI DE 170018
AFL 18.8 | ILP 352 | EPI 95
Lambled 3 | Lambs 5 | Weaned 3

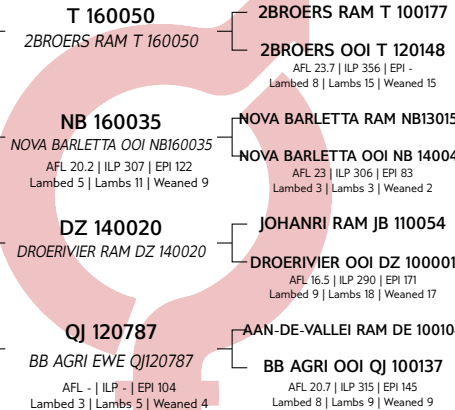

Growth			Reproduction			
Wn. Dir.	Wean Mat.	Post-Wn.	NLW	TWW	AFL	ILP
102	97	100	95	95	105	101
63%	58%	58%	46%	46%	47%	34%



EBV Analysis 2024-02-02

Logix Merit Index	103
Growth Index	104
Reproduction Index	99

SELLER REMARKS: Dragtig - AP19-116, Verwagte Lam Datum 3 May 2024

LOT 9 (F)



RW 210146
RUSWATER OOI RW 210146

Herd Book	SP	
Birth date	2021-08-19	
Age	2.5 years	
Inbreeding	5.42%	
Birth Stat.	1	
AFL	ILP	EPI
-	-	-

F.J. KRUGER
Potchefstroom, North West
0828591867
ruswater.kruger@gmail.com

JB 190017
JOHANRI RAM JB190017

Parentage Sire Dam
DNA
Genomic

RW 190079
RUSWATER EWE RW190079
AFL 24.9 | ILP 266 | EPI 101
Lambled 3 | Lambs 4 | Weaned 4

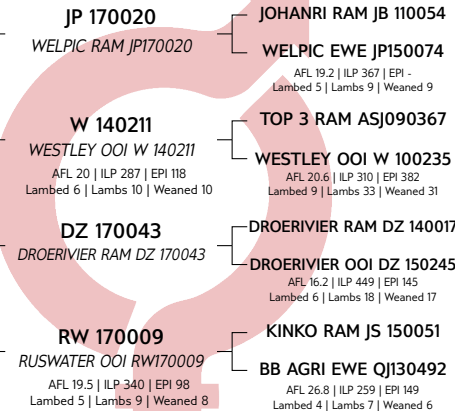

Growth			Reproduction			
Wn. Dir.	Wean Mat.	Post-Wn.	NLW	TWW	AFL	ILP
89	102	94	109	109	99	124
60%	47%	56%	37%	37%	34%	28%



EBV Analysis 2024-02-02

Logix Merit Index	101
Growth Index	93
Reproduction Index	112

SELLER REMARKS: Dragtig - JT21-438, Verwagte Lam Datum 3 May 2024

LOT 10 (F)



F.J. KRUGER
Potchefstroom, North West
0828591867
ruswater.kruger@gmail.com

RW 210161

RUSWATER OOI RW 210161

Kuddeboek	SP	
Geb. dtm	2021-08-23	
Oud.	2.5 jaar	
Inteling	7.34%	
Geb. Status	1	
OEL	ILP	OPI
13.5m	284d	123
Gelam	2	
Lammers	2	
Gespeen	2	

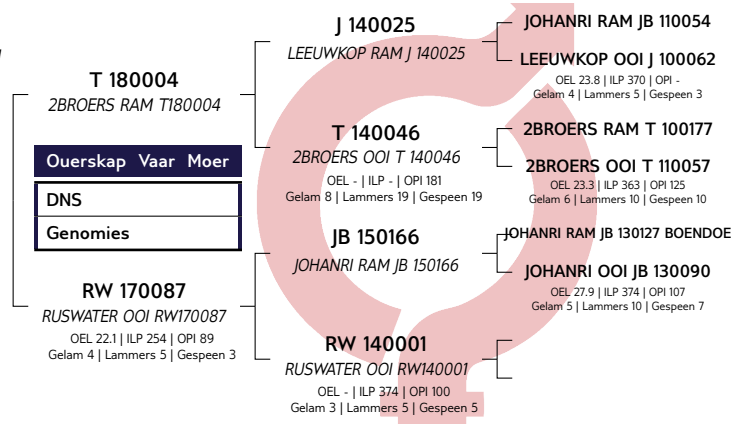

Groi			Reproduksie			
Spn. Dir.	Spn. Mat.	Na-Spn.	GLS	TWW	OEL	ILP
78	110	74	78	78	98	109
61%	58%	55%	45%	45%	42%	36%



Logix Meriete Indeks	77
Groi Indeks	86
Reproduksie Indeks	85

VERKOPER OPMERKINGS: Dragtig - AP19-116, Verwagte Lam Datum 3 May 2024

LOT 11 (F)



F.J. KRUGER
Potchefstroom, North West
0828591867
ruswater.kruger@gmail.com

RW 210167

RUSWATER OOI RW 210167

Kuddeboek	SP	
Geb. dtm	2021-08-25	
Oud.	2.5 jaar	
Inteling	5.28%	
Geb. Status	2	
OEL	ILP	OPI
29.3m	-	-
Gelam	1	
Lammers	1	
Gespeen	0	

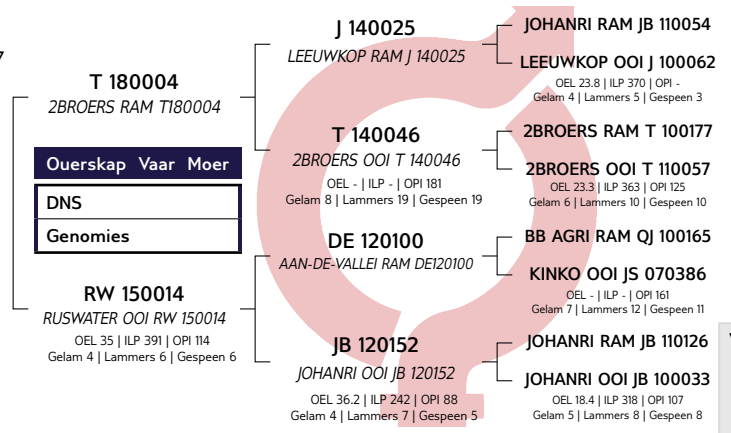

Groi			Reproduksie			
Spn. Dir.	Spn. Mat.	Na-Spn.	GLS	TWW	OEL	ILP
85	99	82	91	91	99	96
61%	55%	57%	44%	44%	40%	33%



Logix Meriete Indeks	85
Groi Indeks	88
Reproduksie Indeks	90

VERKOPER OPMERKINGS: Met Ooi Lam - RW24-01. Met lam.

LOT 12 (F)



F.J. KRUGER
Potchefstroom, North West
0828591867
ruswater.kruger@gmail.com

RW 210183

RUSWATER OOI RW 210183

Kuddeboek	SP	
Geb. dtm	2021-08-28	
Oud.	2.5 jaar	
Inteling	4.42%	
Geb. Status	2	
OEL	ILP	OPI
17m	282d	118
Gelam	2	
Lammers	2	
Gespeen	2	

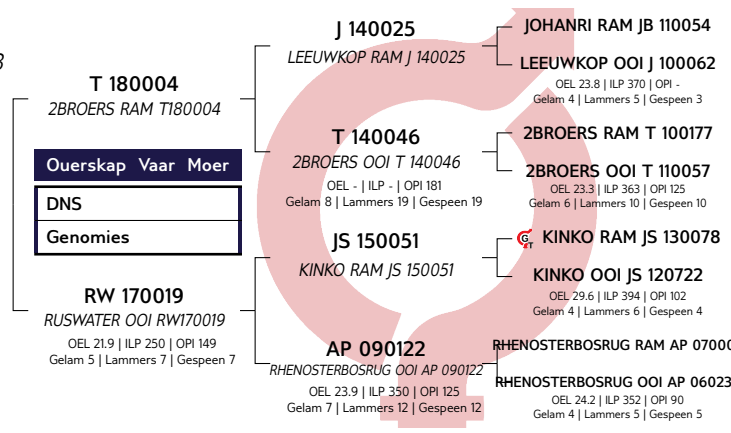

Groi			Reproduksie			
Spn. Dir.	Spn. Mat.	Na-Spn.	GLS	TWW	OEL	ILP
85	96	83	80	80	101	97
64%	61%	59%	51%	51%	47%	39%



Logix Meriete Indeks	78
Groi Indeks	87
Reproduksie Indeks	79

VERKOPER OPMERKINGS: Loop by Ram JT21-438

LOT 13 (F)



RW 220086
RUSWATER OOI RW 220086

Herd Book	SP	
Birth date	2022-05-05	
Age	1.8 years	
Inbreeding	6.4%	
Birth Stat.	1	
AFL	ILP	EPI
17m	-	98
Lambled	1	
Lambs	1	
Weaned	1	

F.J. KRUGER
Potchefstroom, North West
0828591867
ruswater.kruger@gmail.com

JB 190017
JOHANRI RAM JB190017

Parentage Sire Dam

DNA

Genomic

RW 200045
RUSWATER EWE RW200045
AFL 21.4 | ILP - | EPI 88
Lambled 1 | Lambs 1 | Weaned 1

JP 170020
WELPIC RAM JP170020

W 140211
WESTLEY OOI W 140211
AFL 20 | ILP 287 | EPI 118
Lambled 6 | Lambs 10 | Weaned 10

T 180004
2BROERS RAM T180004

RW 190008
RUSWATER OOI RW190008
AFL 15.7 | ILP 397 | EPI 100
Lambled 2 | Lambs 4 | Weaned 2

JOHANRI RAM JB 110054
WELPIC EWE JP150074
AFL 19.2 | ILP 367 | EPI -
Lambled 5 | Lambs 9 | Weaned 9

TOP 3 RAM ASJ090367
WESTLEY OOI W 100235
AFL 20.6 | ILP 310 | EPI 382
Lambled 9 | Lambs 33 | Weaned 31

LEEUEWKOP RAM J 140025
2BROERS OOI T 140046
AFL - | ILP - | EPI 181
Lambled 8 | Lambs 19 | Weaned 19

RHENOSTERBOSRUG RAM AP 160353
RUSWATER OOI RW140014
AFL - | ILP 393 | EPI 97
Lambled 3 | Lambs 5 | Weaned 5

Growth			Reproduction			
Wn. Dir.	Wean Mat.	Post-Wn.	NLW	TWW	AFL	ILP
86	105	90	99	99	91	124
59%	49%	56%	38%	38%	38%	25%



EBV Analysis 2024-02-02

Logix Merit Index	93
Growth Index	92
Reproduction Index	102

SELLER REMARKS: Loop by Ram JT21-438

LOT 14 (F)



RW 220095
RUSWATER OOI RW 220095

Herd Book	SP	
Birth date	2022-05-20	
Age	1.8 years	
Inbreeding	3.75%	
Birth Stat.	2	
AFL	ILP	EPI
14m	-	96
Lambled	1	
Lambs	1	
Weaned	1	

F.J. KRUGER
Potchefstroom, North West
0828591867
ruswater.kruger@gmail.com

JB 190017
JOHANRI RAM JB190017

Parentage Sire Dam

DNA

Genomic

RW 170044
RUSWATER OOI RW170044
AFL 20.1 | ILP 305 | EPI 131
Lambled 7 | Lambs 12 | Weaned 10

JP 170020
WELPIC RAM JP170020

W 140211
WESTLEY OOI W 140211
AFL 20 | ILP 287 | EPI 118
Lambled 6 | Lambs 10 | Weaned 10

AP 140551
RHENOSTERBOSRUG RAM AP 140551

QJ 130423
BB AGRI EWE QJ130423
AFL 17.3 | ILP 459 | EPI 98
Lambled 4 | Lambs 4 | Weaned 2

JOHANRI RAM JB 110054
WELPIC EWE JP150074
AFL 19.2 | ILP 367 | EPI -
Lambled 5 | Lambs 9 | Weaned 9

TOP 3 RAM ASJ090367
WESTLEY OOI W 100235
AFL 20.6 | ILP 310 | EPI 382
Lambled 9 | Lambs 33 | Weaned 31

RHENOSTERBOSRUG RAM AP 110427
RHENOSTERBOSRUG OOI AP 110054
AFL 25 | ILP 363 | EPI 101
Lambled 4 | Lambs 7 | Weaned 7

AAN-DE-VALLEI RAM DE110176
BB AGRI OOI QJ 110334
AFL - | ILP 340 | EPI 113
Lambled 2 | Lambs 4 | Weaned 4

Growth			Reproduction			
Wn. Dir.	Wean Mat.	Post-Wn.	NLW	TWW	AFL	ILP
100	106	102	114	114	93	126
60%	48%	55%	37%	37%	31%	25%



EBV Analysis 2024-02-02

Logix Merit Index	115
Growth Index	106
Reproduction Index	121

SELLER REMARKS: Loop by Ram JT21-438

LOT 15 (F)



RW 220096
RUSWATER OOI RW 220096

Herd Book	SP	
Birth date	2022-05-20	
Age	1.8 years	
Inbreeding	3.75%	
Birth Stat.	2	
AFL	ILP	EPI
-	-	-

F.J. KRUGER
Potchefstroom, North West
0828591867
ruswater.kruger@gmail.com

JB 190017
JOHANRI RAM JB190017

Parentage Sire Dam

DNA

Genomic

RW 170044
RUSWATER OOI RW170044
AFL 20.1 | ILP 305 | EPI 131
Lambled 7 | Lambs 12 | Weaned 10

JP 170020
WELPIC RAM JP170020

W 140211
WESTLEY OOI W 140211
AFL 20 | ILP 287 | EPI 118
Lambled 6 | Lambs 10 | Weaned 10

AP 140551
RHENOSTERBOSRUG RAM AP 140551

QJ 130423
BB AGRI EWE QJ130423
AFL 17.3 | ILP 459 | EPI 98
Lambled 4 | Lambs 4 | Weaned 2

JOHANRI RAM JB 110054
WELPIC EWE JP150074
AFL 19.2 | ILP 367 | EPI -
Lambled 5 | Lambs 9 | Weaned 9

TOP 3 RAM ASJ090367
WESTLEY OOI W 100235
AFL 20.6 | ILP 310 | EPI 382
Lambled 9 | Lambs 33 | Weaned 31

RHENOSTERBOSRUG RAM AP 110427
RHENOSTERBOSRUG OOI AP 110054
AFL 25 | ILP 363 | EPI 101
Lambled 4 | Lambs 7 | Weaned 7

AAN-DE-VALLEI RAM DE110176
BB AGRI OOI QJ 110334
AFL - | ILP 340 | EPI 113
Lambled 2 | Lambs 4 | Weaned 4

Growth			Reproduction			
Wn. Dir.	Wean Mat.	Post-Wn.	NLW	TWW	AFL	ILP
92	108	98	114	114	92	127
60%	48%	55%	37%	37%	31%	25%



EBV Analysis 2024-02-02

Logix Merit Index	109
Growth Index	100
Reproduction Index	120

SELLER REMARKS: Dragtig - AP19-116, Verwagte Lam Datum 3 May 2024

LOT 16 (F)



RW 220117
RUSWATER OOI RW 220117

Kuddeboek	SP	
Geb. dtm	2022-05-26	
Oud.	1.7 jaar	
Inteling	4.6%	
Geb. Status	2	
OEL	ILP	OPI
-	-	-

F.J. KRUGER
Potchefstroom, North West
0828591867
ruswater.kruger@gmail.com

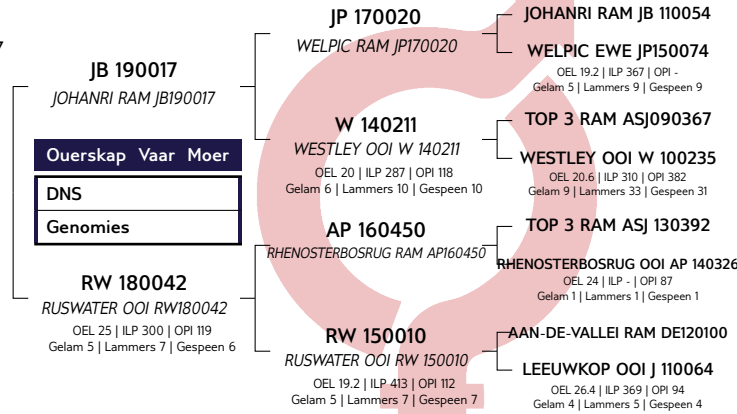

Groeï			Reproduksie			
Spn. Dir.	Spn. Mat.	Na-Spn.	GLS	TWW	OEL	ILP
88	105	99	105	105	105	120
59%	46%	55%	36%	36%	30%	24%



EBV Analise 2024-02-02

Logix Meriete Indeks	101
Groeï Indeks	94
Reproduksie Indeks	112

VERKOPER OPMERKINGS: Dragtig - JT21-438, Verwagte Lam Datum 3 May 2024

LOT 17 (F)



RW 220136
RUSWATER OOI RW 220136

Kuddeboek	SP	
Geb. dtm	2022-08-13	
Oud.	1.5 jaar	
Inteling	4.56%	
Geb. Status	2	
OEL	ILP	OPI
-	-	-

F.J. KRUGER
Potchefstroom, North West
0828591867
ruswater.kruger@gmail.com

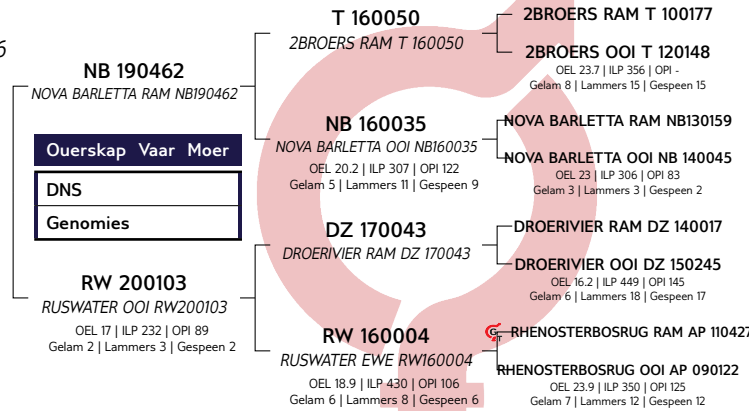

Groeï			Reproduksie			
Spn. Dir.	Spn. Mat.	Na-Spn.	GLS	TWW	OEL	ILP
91	96	87	101	101	115	107
61%	52%	57%	41%	41%	41%	32%



EBV Analise 2024-02-02

Logix Meriete Indeks	98
Groeï Indeks	93
Reproduksie Indeks	105

VERKOPER OPMERKINGS: Loop by Ram JT21-438

LOT 18 (F)



RW 220155
RUSWATER OOI RW 220155

Kuddeboek	SP	
Geb. dtm	2022-10-06	
Oud.	1.4 jaar	
Inteling	7.51%	
Geb. Status	2	
OEL	ILP	OPI
-	-	-

F.J. KRUGER
Potchefstroom, North West
0828591867
ruswater.kruger@gmail.com

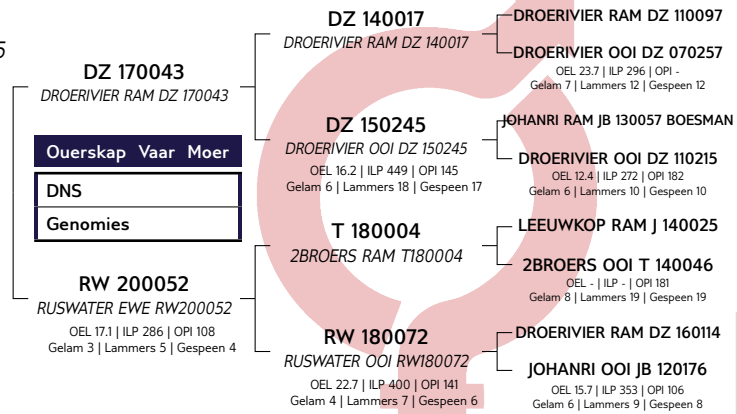

Groeï			Reproduksie			
Spn. Dir.	Spn. Mat.	Na-Spn.	GLS	TWW	OEL	ILP
83	105	81	99	99	100	110
61%	54%	59%	45%	45%	42%	36%



EBV Analise 2024-02-02

Logix Meriete Indeks	91
Groeï Indeks	89
Reproduksie Indeks	103

VERKOPER OPMERKINGS: Dragtig - AP19-116, Verwagte Lam Datum 3 May 2024



LOT 19 (F)



RW 220156
RUSWATER OOI RW 220156

Herd Book	SP	
Birth date	2022-10-06	
Age	1.4 years	
Inbreeding	6.05%	
Birth Stat.	1	
AFL	ILP	EPI
-	-	-

F.J. KRUGER
Potchefstroom, North West
0828591867
ruswater.kruger@gmail.com

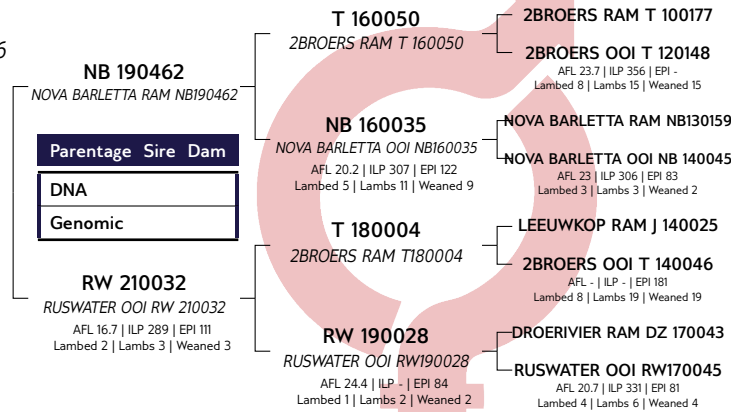

Growth			Reproduction			
Wn. Dir.	Wean Mat.	Post-Wn.	NLW	TWW	AFL	ILP
94	103	86	97	97	117	106
62%	53%	57%	40%	40%	41%	30%



EBV Analysis 2024-02-02

Logix Merit Index	102
Growth Index	99
Reproduction Index	108

SELLER REMARKS: Loop by Ram JT21-438

LOT 20 (F)



RW 220158
RUSWATER OOI RW 220158

Herd Book	SP	
Birth date	2022-10-06	
Age	1.4 years	
Inbreeding	28.45%	
Birth Stat.	2	
AFL	ILP	EPI
-	-	-

F.J. KRUGER
Potchefstroom, North West
0828591867
ruswater.kruger@gmail.com

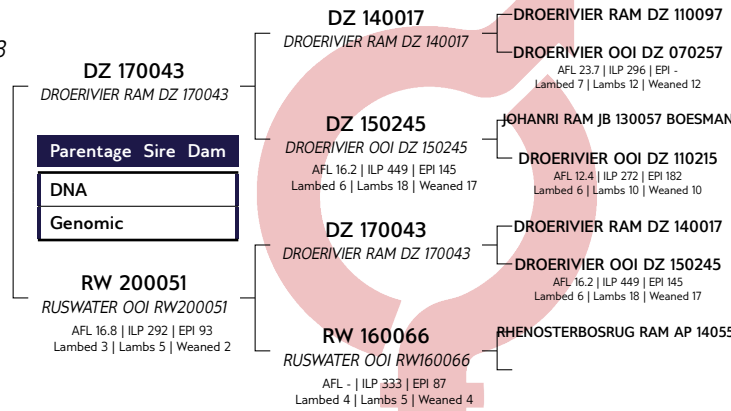

Growth			Reproduction			
Wn. Dir.	Wean Mat.	Post-Wn.	NLW	TWW	AFL	ILP
76	109	76	96	96	104	110
61%	53%	59%	44%	44%	42%	37%



EBV Analysis 2024-02-02

Logix Merit Index	87
Growth Index	84
Reproduction Index	103

SELLER REMARKS: Dragtig - AP19-116, Verwagte Lam Datum 3 May 2024

LOT 21 (F)



RW 220168
RUSWATER OOI RW 220168

Herd Book	SP	
Birth date	2022-10-07	
Age	1.4 years	
Inbreeding	28.45%	
Birth Stat.	2	
AFL	ILP	EPI
-	-	-

F.J. KRUGER
Potchefstroom, North West
0828591867
ruswater.kruger@gmail.com

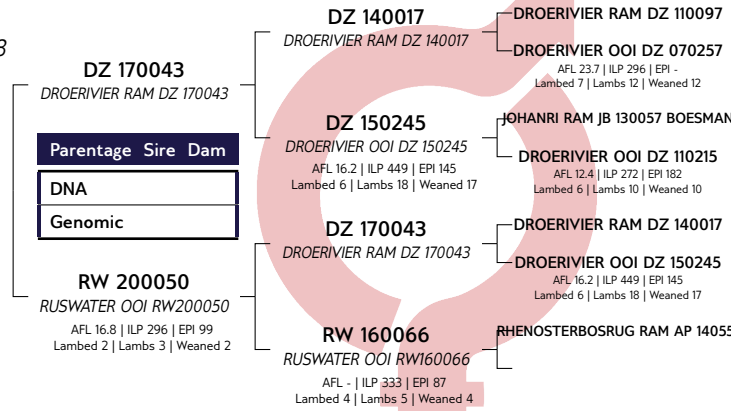

Growth			Reproduction			
Wn. Dir.	Wean Mat.	Post-Wn.	NLW	TWW	AFL	ILP
83	110	82	92	92	104	110
61%	53%	59%	44%	44%	42%	37%



EBV Analysis 2024-02-02

Logix Merit Index	91
Growth Index	92
Reproduction Index	102

SELLER REMARKS: Dragtig - AP19-116, Verwagte Lam Datum 3 May 2024

LOT 22 (F)



RW 220193
RUSWATER OOI RW 220193

Kuddeboek	SP	
Geb. dtm	2022-10-09	
Oud.	1.4 jaar	
Inteling	4.91%	
Geb. Status	2	
OEL	ILP	OPI
-	-	-

F.J. KRUGER
Potchefstroom, North West
0828591867
ruswater.kruger@gmail.com

JB 200084
JOHANRI RAM JB200084

Ouerskap	Vaar	Moer
DNS		
Genomies		

RW 200022
RUSWATER OOI RW200022

OEL 17.1 | ILP 289 | OPI 114
Gelam 3 | Lammers 5 | Gespeen 3

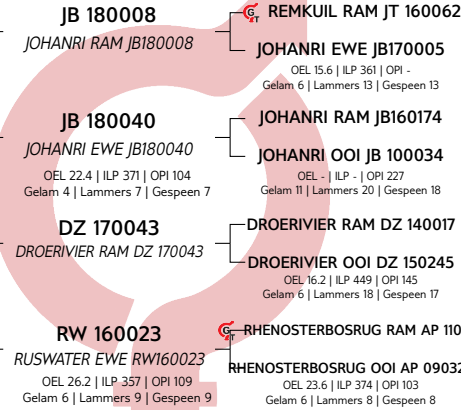

Groi			Reproduksie			
Spn. Dir.	Spn. Mat.	Na-Spn.	GLS	TWW	OEL	ILP
102	99	102	103	103	97	109
62%	47%	54%	34%	34%	31%	26%



EBV Analise 2024-02-02

Logix Meriete Indeks **106**

Groi Indeks **104**

Reproduksie Indeks **106**

VERKOPER OPMERKINGS: Dragtig - AP19-116, Verwagte Lam Datum 3 May 2024

LOT 23 (F)



RW 220198
RUSWATER OOI RW 220198

Kuddeboek	SP	
Geb. dtm	2022-10-09	
Oud.	1.4 jaar	
Inteling	7.58%	
Geb. Status	2	
OEL	ILP	OPI
-	-	-

F.J. KRUGER
Potchefstroom, North West
0828591867
ruswater.kruger@gmail.com

DZ 170043
DROERIVIER RAM DZ 170043

Ouerskap	Vaar	Moer
DNS		
Genomies		

RW 210027
RUSWATER OOI RW 210027

OEL 16.8 | ILP 288 | OPI 99
Gelam 2 | Lammers 3 | Gespeen 3

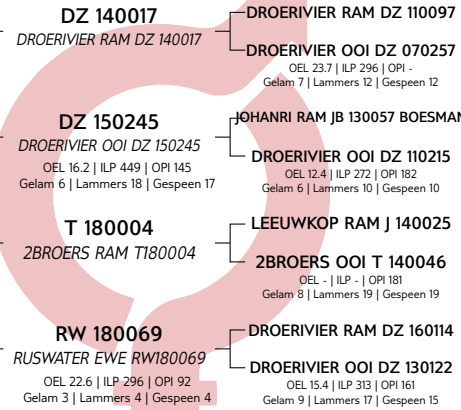

Groi			Reproduksie			
Spn. Dir.	Spn. Mat.	Na-Spn.	GLS	TWW	OEL	ILP
86	97	84	98	98	102	108
61%	54%	59%	44%	44%	42%	36%



EBV Analise 2024-02-02

Logix Meriete Indeks **90**

Groi Indeks **88**

Reproduksie Indeks **98**

VERKOPER OPMERKINGS: Dragtig - AP19-116, Verwagte Lam Datum 3 May 2024

LOT 24 (F)



RW 230088
RUSWATER OOI RW 230088

Kuddeboek	SP	
Geb. dtm	2023-02-01	
Oud.	1 jaar	
Inteling	6.17%	
Geb. Status	3	
OEL	ILP	OPI
-	-	-

F.J. KRUGER
Potchefstroom, North West
0828591867
ruswater.kruger@gmail.com

JB 200084
JOHANRI RAM JB200084

Ouerskap	Vaar	Moer
DNS		
Genomies		

RW 190077
RUSWATER EWE RW190077

OEL 25.2 | ILP 261 | OPI 107
Gelam 3 | Lammers 6 | Gespeen 5

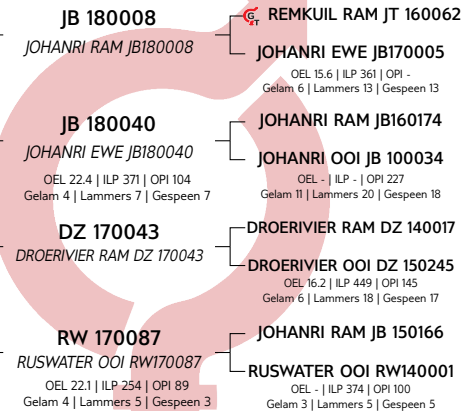

Groi			Reproduksie			
Spn. Dir.	Spn. Mat.	Na-Spn.	GLS	TWW	OEL	ILP
96	99	98	98	98	97	110
62%	48%	45%	33%	33%	29%	24%



EBV Analise 2024-02-02

Logix Meriete Indeks **99**

Groi Indeks **99**

Reproduksie Indeks **100**

VERKOPER OPMERKINGS: Loop by Ram JT21-438

LOT 25 (F)



RW 230106
RUSWATER OOI RW 230106

Herd Book	SP	
Birth date	2023-02-02	
Age	1 years	
Inbreeding	5.26%	
Birth Stat.	2	
AFL	ILP	EPI
-	-	-

F.J. KRUGER
Potchefstroom, North West
0828591867
ruswater.kruger@gmail.com

JB 200084
JOHANRI RAM JB200084

Parentage Sire Dam
DNA
Genomic

RW 190079
RUSWATER EWE RW190079
AFL 24.9 | ILP 266 | EPI 101
Lambd 3 | Lams 4 | Weaned 4

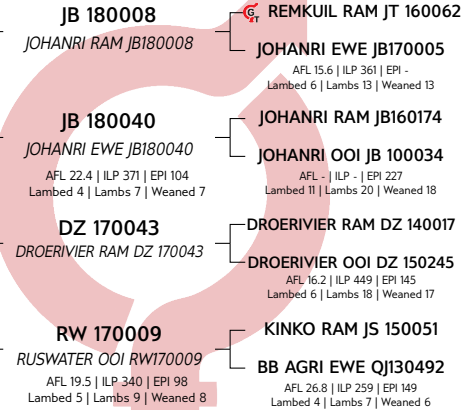

Growth			Reproduction			
Wn. Dir.	Wean Mat.	Post-Wn.	NLW	TWW	AFL	ILP
101	96	104	102	102	101	107
62%	48%	46%	34%	34%	30%	25%



EBV Analysis 2024-02-02

Logix Merit Index	104
Growth Index	103
Reproduction Index	104

SELLER REMARKS: Loop by Ram JT21-438

LOT 26 (F)



RW 200051
RUSWATER OOI RW200051

Herd Book	B	
Birth date	2020-07-23	
Age	3.6 years	
Inbreeding	4.49%	
Birth Stat.	2	
AFL	ILP	EPI
16.8m	292d	93
Lambd	3	
Lams	5	
Weaned	2	

F.J. KRUGER
Potchefstroom, North West
0828591867
ruswater.kruger@gmail.com

DZ 170043
DROERIVIER RAM DZ 170043

Parentage Sire Dam
DNA
Genomic

RW 160066
RUSWATER OOI RW160066
AFL - | ILP 333 | EPI 87
Lambd 4 | Lams 5 | Weaned 4

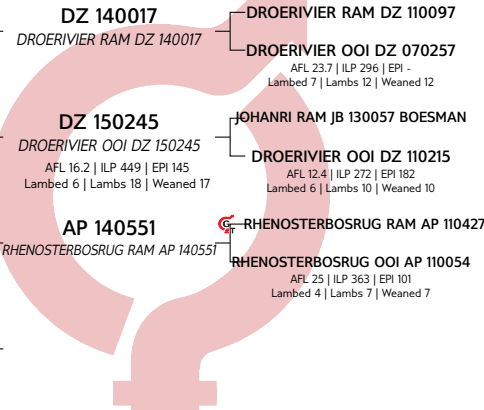

Growth			Reproduction			
Wn. Dir.	Wean Mat.	Post-Wn.	NLW	TWW	AFL	ILP
75	111	72	105	105	103	113
61%	61%	59%	44%	44%	43%	37%



EBV Analysis 2024-02-02

Logix Merit Index	91
Growth Index	84
Reproduction Index	111

SELLER REMARKS: Dragtig - JT21-438, Verwagte Lam Datum 3 May 2024

LOT 27 (F)



RW 200058
RUSWATER EWE RW200058

Herd Book	B	
Birth date	2020-07-23	
Age	3.6 years	
Inbreeding	4.22%	
Birth Stat.	2	
AFL	ILP	EPI
16.6m	295d	104
Lambd	3	
Lams	4	
Weaned	4	

F.J. KRUGER
Potchefstroom, North West
0828591867
ruswater.kruger@gmail.com

DZ 170043
DROERIVIER RAM DZ 170043

Parentage Sire Dam
DNA
Genomic

RW 160072
RUSWATER OOI RW 160072
AFL - | ILP 308 | EPI 106
Lambd 4 | Lams 7 | Weaned 5

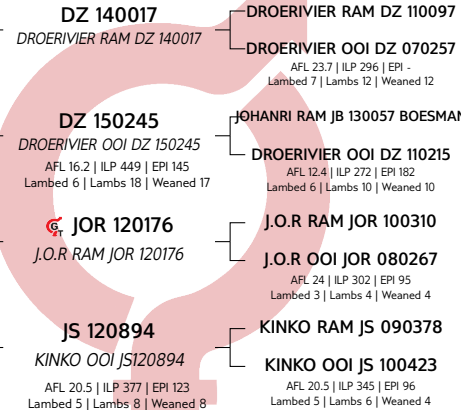

Growth			Reproduction			
Wn. Dir.	Wean Mat.	Post-Wn.	NLW	TWW	AFL	ILP
94	89	95	92	92	110	99
64%	60%	60%	52%	52%	47%	42%



EBV Analysis 2024-02-02

Logix Merit Index	91
Growth Index	92
Reproduction Index	91

SELLER REMARKS: Dragtig - AP19-116, Verwagte Lam Datum 3 May 2024

LOT 28 (F)



RW 220029
RUSWATER OOI RW 220029

Kuddeboek	B	
Geb. dtm	2022-05-02	
Oud.	1.8 jaar	
Inteling	4.94%	
Geb. Status	1	
OEL	ILP	OPI
14.6m	-	110
Gelam	1	
Lammers	2	
Gespeen	2	

F.J. KRUGER
Potchefstroom, North West
0828591867
ruswater.kruger@gmail.com

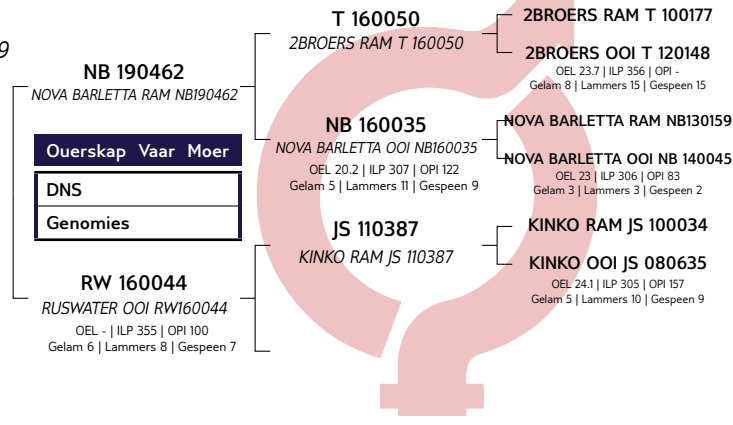

Groeï			Reproduksie			
Spn. Dir.	Spn. Mat.	Na-Spn.	GLS	TWW	OEL	ILP
88	107	79	121	121	120	113
60%	53%	55%	38%	38%	42%	28%



EBV Analise 2024-02-02

Logix Meriete Indeks	113
Groeï Indeks	94
Reproduksie Indeks	133

VERKOPER OPMERKINGS: Loop by Ram JT21-438

LOT 29 (F)



RW 220179
RUSWATER OOI RW220179

Kuddeboek	B	
Geb. dtm	2022-10-07	
Oud.	1.4 jaar	
Inteling	4.06%	
Geb. Status	1	
OEL	ILP	OPI
-	-	-

F.J. KRUGER
Potchefstroom, North West
0828591867
ruswater.kruger@gmail.com

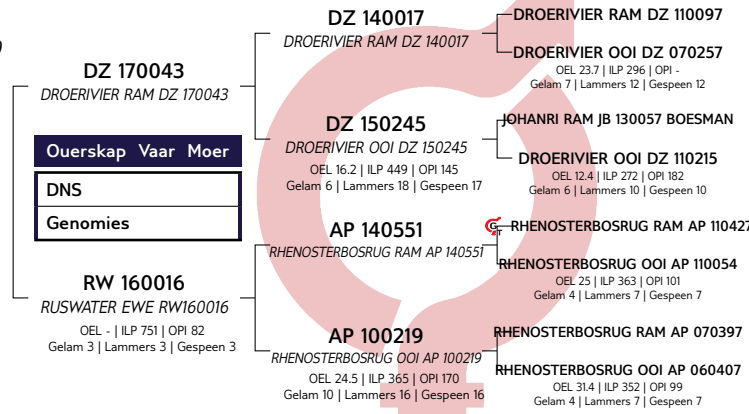

Groeï			Reproduksie			
Spn. Dir.	Spn. Mat.	Na-Spn.	GLS	TWW	OEL	ILP
84	98	88	93	93	102	111
61%	54%	57%	45%	45%	41%	36%



EBV Analise 2024-02-02

Logix Meriete Indeks	86
Groeï Indeks	86
Reproduksie Indeks	94

VERKOPER OPMERKINGS: Dragtig - AP19-116, Verwagte Lam Datum 3 May 2024. Met lam.

LOT 30 (F)



RW 220227
RUSWATER OOI RW 220227

Kuddeboek	B	
Geb. dtm	2022-10-28	
Oud.	1.3 jaar	
Inteling	6.44%	
Geb. Status	2	
OEL	ILP	OPI
-	-	-

F.J. KRUGER
Potchefstroom, North West
0828591867
ruswater.kruger@gmail.com

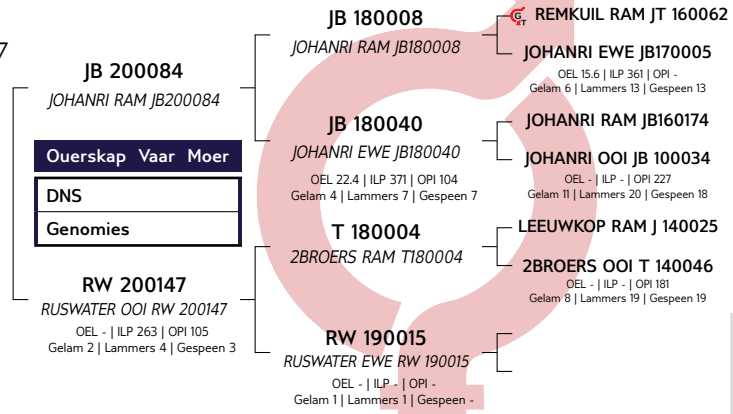

Groeï			Reproduksie			
Spn. Dir.	Spn. Mat.	Na-Spn.	GLS	TWW	OEL	ILP
99	108	97	105	105	97	112
59%	44%	51%	30%	30%	27%	23%



EBV Analise 2024-02-02

Logix Meriete Indeks	109
Groeï Indeks	106
Reproduksie Indeks	113

VERKOPER OPMERKINGS: Dragtig - AP19-116, Verwagte Lam Datum 3 May 2024



LOT 31 (M)



RW 220139
RUSWATER RAM RW 220139

Herd Book	SP
Birth date	2022-08-23
Age	1.5 years
Inbreeding	4.09%
Birth Stat.	2
Progeny	None

F.J. KRUGER
Potchefstroom, North West
0828591867
ruswater.kruger@gmail.com

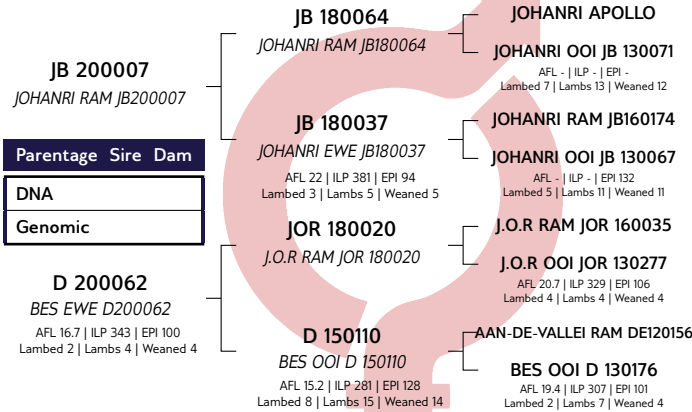

Growth			Reproduction			
Wn. Dir.	Wean Mat.	Post-Wn.	NLW	TWW	AFL	ILP
101	95	101	83	83	83	102
60%	44%	49%	31%	31%	32%	23%



EBV Analysis 2024-02-02

Logix Merit Index	89
Growth Index	102
Reproduction Index	79

SELLER REMARKS: JB20-007 "007"- Seun

LOT 32 (M)



RW 220196
RUSWATER RAM RW 220196

Herd Book	SP
Birth date	2022-10-09
Age	1.4 years
Inbreeding	5.61%
Birth Stat.	1
Progeny	None

F.J. KRUGER
Potchefstroom, North West
0828591867
ruswater.kruger@gmail.com

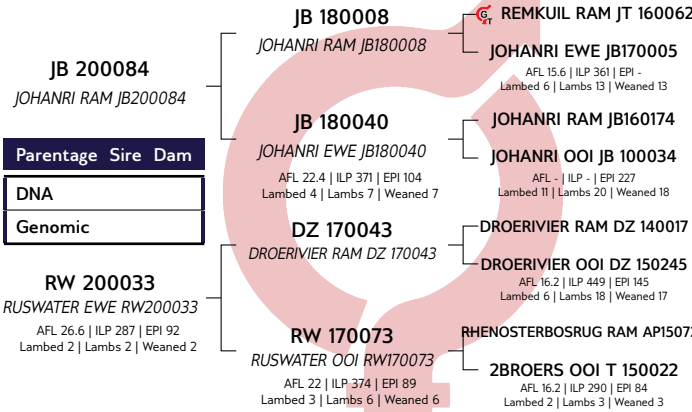

Growth			Reproduction			
Wn. Dir.	Wean Mat.	Post-Wn.	NLW	TWW	AFL	ILP
100	97	103	108	108	98	112
61%	46%	53%	32%	32%	30%	25%



EBV Analysis 2024-02-02

Logix Merit Index	107
Growth Index	101
Reproduction Index	109

SELLER REMARKS:

LOT 33 (M)



RW 220145
RUSWATER RAM RW 220145

Herd Book	SP
Birth date	2022-10-04
Age	1.4 years
Inbreeding	4.78%
Birth Stat.	1
Progeny	None

F.J. KRUGER
Potchefstroom, North West
0828591867
ruswater.kruger@gmail.com

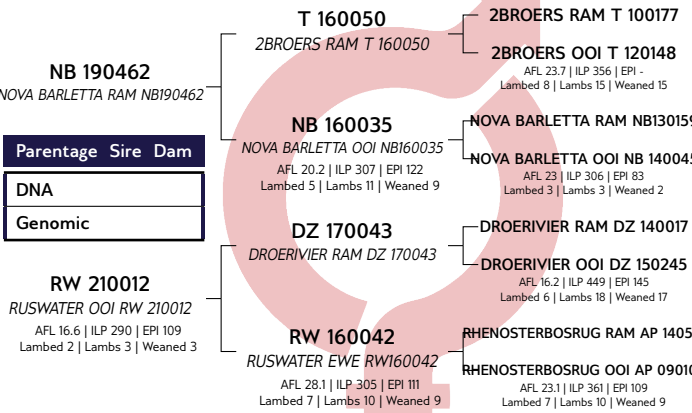

Growth			Reproduction			
Wn. Dir.	Wean Mat.	Post-Wn.	NLW	TWW	AFL	ILP
97	100	94	99	99	122	109
61%	52%	57%	41%	41%	40%	31%



EBV Analysis 2024-02-02

Logix Merit Index	106
Growth Index	101
Reproduction Index	110

SELLER REMARKS: Tweeling

LOT 34 (M)



RW 220161
RUSWATER RAM RW 220161

Kuddeboek	SP
Geb. dtm	2022-10-06
Oud.	1.4 jaar
Inteling	6.13%
Geb. Status	1
Nageslag	
Geen	

F.J. KRUGER
Potchefstroom, North West
0828591867
ruswater.kruger@gmail.com

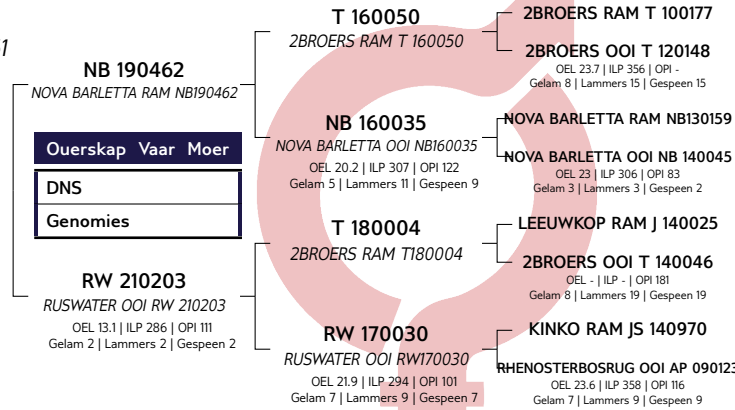

Groeï			Reproduksie			
Spn. Dir.	Spn. Mat.	Na-Spn.	GLS	TWW	OEL	ILP
101	99	97	96	96	117	110
61%	51%	57%	40%	40%	40%	30%



EBV Analise 2024-02-02

Logix Meriete Indeks	105
Groeï Indeks	103
Reproduksie Indeks	105

VERKOPER OPMERKINGS: Tweeling

LOT 35 (M)



RW 220187
RUSWATER RAM RW 220187

Kuddeboek	SP
Geb. dtm	2022-10-08
Oud.	1.4 jaar
Inteling	4.72%
Geb. Status	1
Nageslag	
Geen	

F.J. KRUGER
Potchefstroom, North West
0828591867
ruswater.kruger@gmail.com

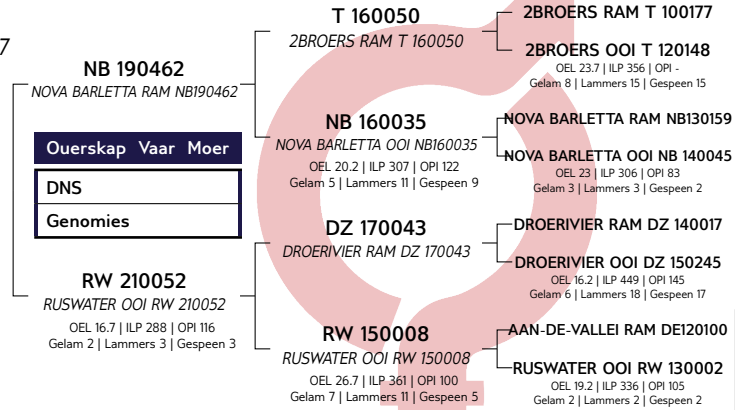

Groeï			Reproduksie			
Spn. Dir.	Spn. Mat.	Na-Spn.	GLS	TWW	OEL	ILP
102	103	98	97	97	116	106
61%	51%	57%	40%	40%	40%	31%



EBV Analise 2024-02-02

Logix Meriete Indeks	108
Groeï Indeks	107
Reproduksie Indeks	109

VERKOPER OPMERKINGS:

LOT 36 (M)



RW 220194
RUSWATER RAM RW 220194

Kuddeboek	SP
Geb. dtm	2022-10-09
Oud.	1.4 jaar
Inteling	5.58%
Geb. Status	1
Nageslag	
Geen	

F.J. KRUGER
Potchefstroom, North West
0828591867
ruswater.kruger@gmail.com

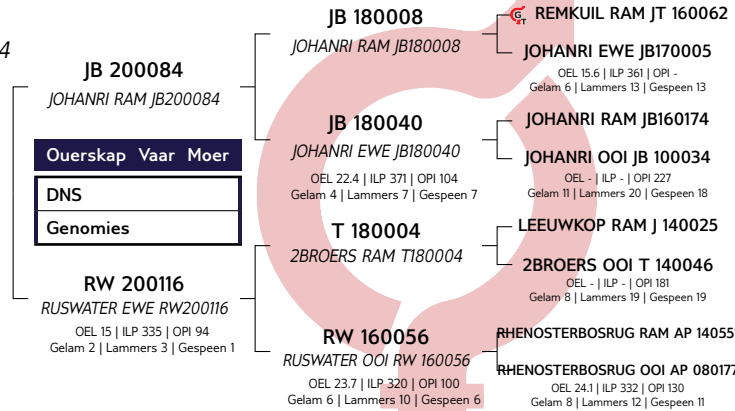

Groeï			Reproduksie			
Spn. Dir.	Spn. Mat.	Na-Spn.	GLS	TWW	OEL	ILP
103	100	103	98	98	98	109
61%	45%	53%	33%	33%	30%	24%



EBV Analise 2024-02-02

Logix Meriete Indeks	105
Groeï Indeks	106
Reproduksie Indeks	103

VERKOPER OPMERKINGS: Tweeling



LOT 37 (M)



RW 220149
RUSWATER RAM RW 220149

Herd Book	SP
Birth date	2022-10-05
Age	1.4 years
Inbreeding	7.28%
Birth Stat.	2
Progeny	None

F.J. KRUGER
Potchefstroom, North West
0828591867
ruswater.kruger@gmail.com

DZ 170043
DROERIVIER RAM DZ 170043

Parentage Sire Dam
DNA
Genomic

RW 200040
RUSWATER EWE RW200040
AFL 15.4 | ILP 313 | EPI 115
Lambd 3 | Lams 4 | Weaned 3

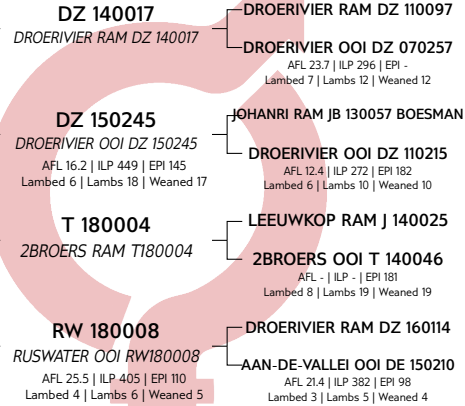

Growth			Reproduction			
Wn. Dir.	Wean Mat.	Post-Wn.	NLW	TWW	AFL	ILP
90	109	87	94	94	106	105
61%	54%	59%	45%	45%	42%	36%



EBV Analysis 2024-02-02

Logix Merit Index	98
Growth Index	98
Reproduction Index	105

SELLER REMARKS: Tweeling

LOT 38 (M)



RW 220190
RUSWATER RAM RW 220190

Herd Book	SP
Birth date	2022-10-09
Age	1.4 years
Inbreeding	7.32%
Birth Stat.	1
Progeny	None

F.J. KRUGER
Potchefstroom, North West
0828591867
ruswater.kruger@gmail.com

DZ 170043
DROERIVIER RAM DZ 170043

Parentage Sire Dam
DNA
Genomic

RW 210104
RUSWATER OOI RW 210104
AFL 16.4 | ILP - | EPI 102
Lambd 1 | Lams 1 | Weaned 1

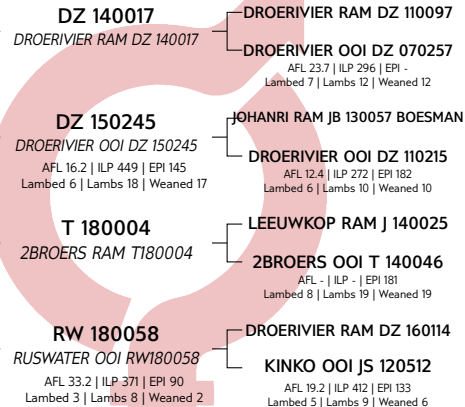

Growth			Reproduction			
Wn. Dir.	Wean Mat.	Post-Wn.	NLW	TWW	AFL	ILP
90	102	89	93	93	104	107
61%	53%	58%	44%	44%	42%	35%



EBV Analysis 2024-02-02

Logix Merit Index	94
Growth Index	95
Reproduction Index	98

SELLER REMARKS: Tweeling

LOT 39 (M)



RW 220171
RUSWATER RAM RW 220171

Herd Book	SP
Birth date	2022-10-07
Age	1.4 years
Inbreeding	6.13%
Birth Stat.	1
Progeny	None

F.J. KRUGER
Potchefstroom, North West
0828591867
ruswater.kruger@gmail.com

NB 190462
NOVA BARLETTA RAM NB190462

Parentage Sire Dam
DNA
Genomic

RW 210014
RUSWATER OOI RW 210014
AFL 16.7 | ILP - | EPI 91
Lambd 1 | Lams 1 | Weaned 1

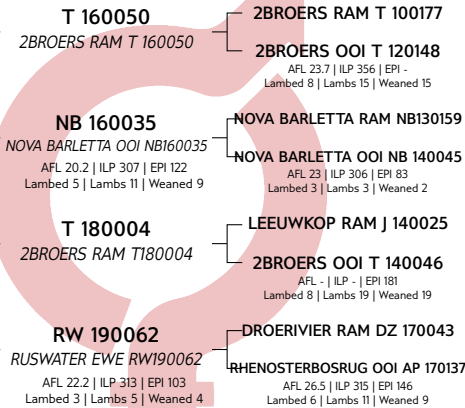

Growth			Reproduction			
Wn. Dir.	Wean Mat.	Post-Wn.	NLW	TWW	AFL	ILP
95	104	90	93	93	116	109
61%	51%	57%	40%	40%	41%	30%



EBV Analysis 2024-02-02

Logix Merit Index	102
Growth Index	101
Reproduction Index	105

SELLER REMARKS: Tweeling

LOT 40 (M)



RW 220167
RUSWATER RAM RW 220167

Kuddeboek	SP
Geb. dtm	2022-10-07
Oud.	1.4 jaar
Inteling	5.13%
Geb. Status	1
Nageslag	
Geen	

F.J. KRUGER
Potchefstroom, North West
0828591867
ruswater.kruger@gmail.com

JB 200084
JOHANRI RAM JB200084

Ouerskap Vaar Moer
DNS
Genomies

RW 200100
RUSWATER EWE RW200100

OEL 16.9 | ILP 289 | OPI 84
Gelum 2 | Lammers 2 | Gespeen 1

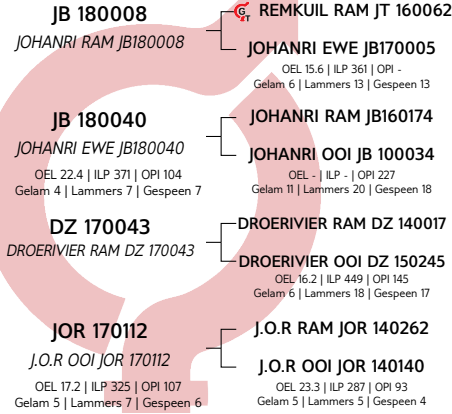

Groi			Reproduksie			
Spn. Dir.	Spn. Mat.	Na-Spn.	GLS	TWW	OEL	ILP
101	97	101	101	101	98	116
61%	46%	53%	33%	33%	31%	25%



EBV Analise 2024-02-02

Logix Meriete Indeks	104
Groi Indeks	102
Reproduksie Indeks	103

VERKOPER OPMERKINGS:

LOT 41 (M)



RW 220188
RUSWATER RAM RW 220188

Kuddeboek	SP
Geb. dtm	2022-10-08
Oud.	1.4 jaar
Inteling	7.28%
Geb. Status	1
Nageslag	
Geen	

F.J. KRUGER
Potchefstroom, North West
0828591867
ruswater.kruger@gmail.com

DZ 170043
DROERIVIER RAM DZ 170043

Ouerskap Vaar Moer
DNS
Genomies

RW 210086
RUSWATER OOI RW 210086

OEL 16.7 | ILP - | OPI 91
Gelum 1 | Lammers 1 | Gespeen 1

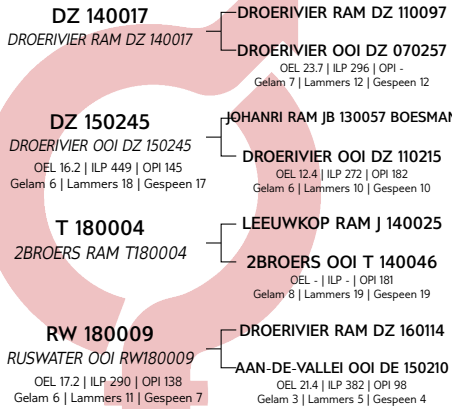

Groi			Reproduksie			
Spn. Dir.	Spn. Mat.	Na-Spn.	GLS	TWW	OEL	ILP
85	106	80	91	91	104	108
61%	53%	59%	45%	45%	42%	36%



EBV Analise 2024-02-02

Logix Meriete Indeks	90
Groi Indeks	91
Reproduksie Indeks	98

VERKOPER OPMERKINGS:

LOT 42 (M)



RW 220178
RUSWATER RAM RW 220178

Kuddeboek	SP
Geb. dtm	2022-10-07
Oud.	1.4 jaar
Inteling	5.95%
Geb. Status	1
Nageslag	
Geen	

F.J. KRUGER
Potchefstroom, North West
0828591867
ruswater.kruger@gmail.com

NB 190462
NOVA BARLETTA RAM NB190462

Ouerskap Vaar Moer
DNS
Genomies

RW 210151
RUSWATER OOI RW 210151

OEL 13.5 | ILP - | OPI 95
Gelum 1 | Lammers 1 | Gespeen 1

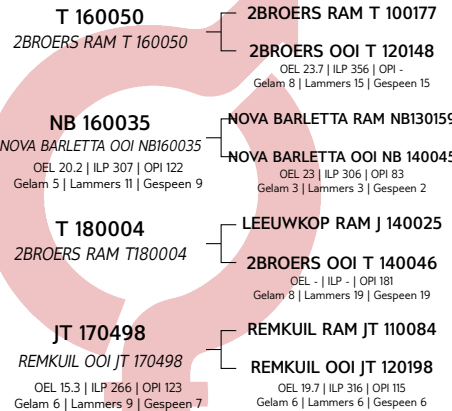

Groi			Reproduksie			
Spn. Dir.	Spn. Mat.	Na-Spn.	GLS	TWW	OEL	ILP
97	103	91	95	95	115	108
61%	52%	57%	41%	41%	41%	31%



EBV Analise 2024-02-02

Logix Meriete Indeks	103
Groi Indeks	102
Reproduksie Indeks	106

VERKOPER OPMERKINGS:

LOT 43 (M)



LP 220033
LABARIE RAM LP220033

Herd Book	SP
Birth date	2022-08-12
Age	1.5 years
Inbreeding	4.35%
Birth Stat.	1
Progeny	None

LABARIE
Brakpan, Gauteng
0833241459
info@labarie.co.za

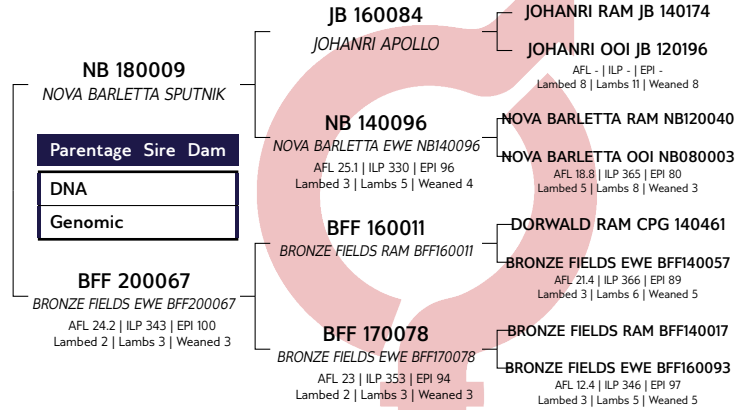

Growth			Reproduction			
Wn. Dir.	Wean Mat.	Post-Wn.	NLW	TWW	AFL	ILP
116	97	113	96	96	126	92
60%	54%	49%	45%	45%	44%	35%



EBV Analysis 2024-02-02

Logix Merit Index	118
Growth Index	118
Reproduction Index	109

SELLER REMARKS: Sputnik Seun

LOT 44 (M)



LP 220041
LABARIE RAM LP220041

Herd Book	SP
Birth date	2022-08-30
Age	1.5 years
Inbreeding	4.13%
Birth Stat.	2
Progeny	None

LABARIE
Brakpan, Gauteng
0833241459
info@labarie.co.za

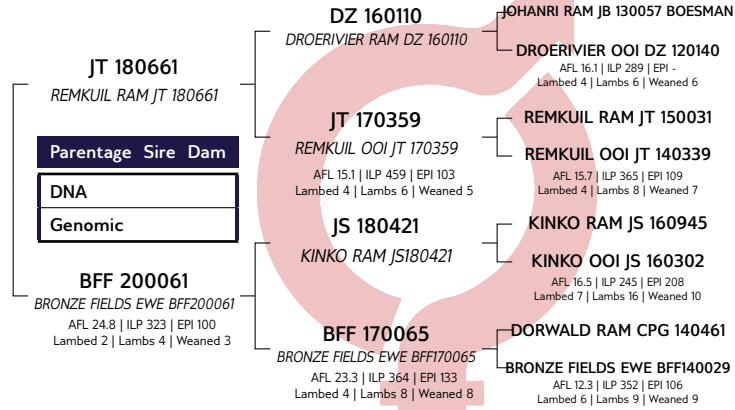

Growth			Reproduction			
Wn. Dir.	Wean Mat.	Post-Wn.	NLW	TWW	AFL	ILP
112	102	119	96	96	96	93
52%	42%	47%	31%	31%	32%	22%



EBV Analysis 2024-02-02

Logix Merit Index	110
Growth Index	116
Reproduction Index	101

SELLER REMARKS:

LOT 45 (M)



RW 220154
RUSWATER RAM RW 220154

Herd Book	SP
Birth date	2022-10-06
Age	1.4 years
Inbreeding	7.51%
Birth Stat.	2
Progeny	None

F.J. KRUGER
Potchefstroom, North West
0828591867
ruswater.kruger@gmail.com

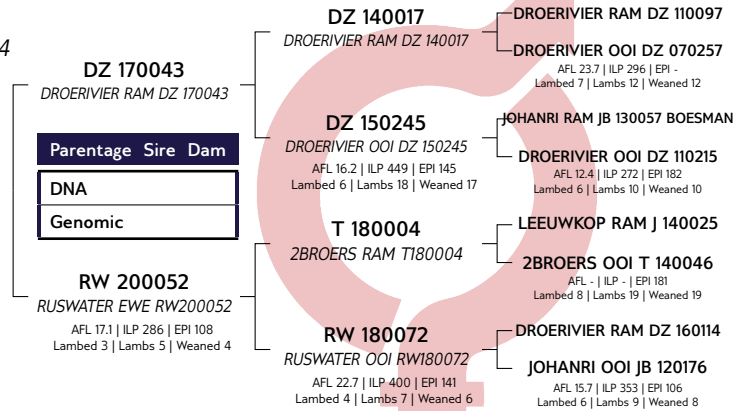

Growth			Reproduction			
Wn. Dir.	Wean Mat.	Post-Wn.	NLW	TWW	AFL	ILP
84	104	79	99	99	100	110
61%	54%	59%	45%	45%	42%	36%



EBV Analysis 2024-02-02

Logix Merit Index	91
Growth Index	89
Reproduction Index	102

SELLER REMARKS:

LOT 46 (M)



RW 220176
RUSWATER RAM RW 220176

Kuddeboek	SP
Geb. dtm	2022-10-07
Oud.	1.4 jaar
Inteling	4.64%
Geb. Status	2
Nageslag	
Geen	

F.J. KRUGER
Potchefstroom, North West
0828591867
ruswater.kruger@gmail.com

JB 200084 JOHANRI RAM JB200084
Ouerskap Vaar Moer
DNS
Genomies
DZ 190277 DROERIVIER OOI DZ 190277 OEL 30.2 ILP 254 OPI 84 Gelam 2 Lammers 3 Gespeen 1

JB 180008 JOHANRI RAM JB180008	REMKUIL RAM JT 160062
JB 180040 JOHANRI EWE JB180040 OEL 22.4 ILP 371 OPI 104 Gelam 4 Lammers 7 Gespeen 7	JOHANRI EWE JB170005 OEL 15.6 ILP 361 OPI - Gelam 6 Lammers 13 Gespeen 13
DZ 180078 DROERIVIER RAM DZ 180078	JOHANRI RAM JB160174
DZ 170253 DROERIVIER OOI DZ 170253 OEL 20.3 ILP 339 OPI 93 Gelam 4 Lammers 6 Gespeen 5	JOHANRI OOI JB 100034 OEL - ILP - OPI 227 Gelam 11 Lammers 20 Gespeen 18
	DROERIVIER RAM DZ 160084
	DROERIVIER OOI DZ 140078 OEL 17.1 ILP 318 OPI 130 Gelam 6 Lammers 13 Gespeen 13
	DROERIVIER RAM DZ 140017
	DROERIVIER OOI DZ 150242 OEL 16.2 ILP 449 OPI 137 Gelam 6 Lammers 15 Gespeen 15

Groi			Reproduksie			
Spn. Dir.	Spn. Mat.	Na-Spn.	GLS	TWW	OEL	ILP
114	94	111	104	104	90	112
61%	45%	50%	31%	31%	28%	24%



Logix Meriete Indeks	114
Groi Indeks	115
Reproduksie Indeks	104

VERKOPER OPMERKINGS:

LOT 47 (M)



RW 220200
RUSWATER RAM RW 220200

Kuddeboek	SP
Geb. dtm	2022-10-09
Oud.	1.4 jaar
Inteling	5.42%
Geb. Status	2
Nageslag	
Geen	

F.J. KRUGER
Potchefstroom, North West
0828591867
ruswater.kruger@gmail.com

DZ 170043 DROERIVIER RAM DZ 170043
Ouerskap Vaar Moer
DNS
Genomies
RW 180082 RUSWATER EWE RW180082 OEL 22.6 ILP 301 OPI 115 Gelam 5 Lammers 9 Gespeen 8

DZ 140017 DROERIVIER RAM DZ 140017	DROERIVIER RAM DZ 110097
DZ 150245 DROERIVIER OOI DZ 150245 OEL 16.2 ILP 449 OPI 145 Gelam 6 Lammers 18 Gespeen 17	DROERIVIER OOI DZ 070257 OEL 23.7 ILP 296 OPI - Gelam 7 Lammers 12 Gespeen 12
JP 170001 WELPIC RAM JP170001	JOHANRI RAM JB 130057 BOESMAN
JOR 170027 J.O.R OOI JOR 170027 OEL 16.1 ILP 314 OPI 127 Gelam 7 Lammers 9 Gespeen 8	DROERIVIER OOI DZ 110215 OEL 12.4 ILP 272 OPI 182 Gelam 6 Lammers 10 Gespeen 10
	JOHANRI RAM JB 120113
	WELPIC EWE JP110100 OEL 31.8 ILP 381 OPI 100 Gelam 7 Lammers 10 Gespeen 8
	JOHANRI RAM JB 150029
	J.O.R OOI JOR 140281 OEL 19.5 ILP 382 OPI 88 Gelam 2 Lammers 3 Gespeen 3

Groi			Reproduksie			
Spn. Dir.	Spn. Mat.	Na-Spn.	GLS	TWW	OEL	ILP
91	101	88	96	96	107	119
62%	56%	58%	47%	47%	42%	37%



Logix Meriete Indeks	97
Groi Indeks	95
Reproduksie Indeks	103

VERKOPER OPMERKINGS:

LOT 48 (M)



RW 220163
RUSWATER RAM RW 220163

Kuddeboek	SP
Geb. dtm	2022-10-07
Oud.	1.4 jaar
Inteling	5.99%
Geb. Status	2
Nageslag	
Geen	

F.J. KRUGER
Potchefstroom, North West
0828591867
ruswater.kruger@gmail.com

JB 200084 JOHANRI RAM JB200084
Ouerskap Vaar Moer
DNS
Genomies
RW 200080 RUSWATER EWE RW200080 OEL 16.8 ILP 294 OPI 104 Gelam 2 Lammers 5 Gespeen 4

JB 180008 JOHANRI RAM JB180008	REMKUIL RAM JT 160062
JB 180040 JOHANRI EWE JB180040 OEL 22.4 ILP 371 OPI 104 Gelam 4 Lammers 7 Gespeen 7	JOHANRI EWE JB170005 OEL 15.6 ILP 361 OPI - Gelam 6 Lammers 13 Gespeen 13
DZ 170043 DROERIVIER RAM DZ 170043	JOHANRI RAM JB160174
RW 170064 RUSWATER OOI RW170064 OEL 17.3 ILP 300 OPI 118 Gelam 7 Lammers 10 Gespeen 9	JOHANRI OOI JB 100034 OEL - ILP - OPI 227 Gelam 11 Lammers 20 Gespeen 18
	DROERIVIER RAM DZ 140017
	DROERIVIER OOI DZ 150245 OEL 16.2 ILP 449 OPI 145 Gelam 6 Lammers 18 Gespeen 17
	JOHANRI RAM JB 150166
	RHENOSTERBOSRUG OOI AP 130191 OEL 27.3 ILP 352 OPI 119 Gelam 7 Lammers 11 Gespeen 9

Groi			Reproduksie			
Spn. Dir.	Spn. Mat.	Na-Spn.	GLS	TWW	OEL	ILP
98	100	97	103	103	96	99
62%	47%	54%	33%	33%	30%	25%



Logix Meriete Indeks	102
Groi Indeks	101
Reproduksie Indeks	104

VERKOPER OPMERKINGS: KOMMERSIEEL

LOT 49 (M)



RW 220147
RUSWATER RAM RW 220147

Herd Book	SP
Birth date	2022-10-05
Age	1.4 years
Inbreeding	7.28%
Birth Stat.	1
Progeny	None

F.J. KRUGER
Potchefstroom, North West
0828591867
ruswater.kruger@gmail.com

DZ 170043
DROERIVIER RAM DZ 170043

Parentage Sire Dam
DNA
Genomic

RW 200041
RUSWATER EWE RW200041
AFL 15.9 | ILP 357 | EPI 143
Lambd 3 | Lams 5 | Weaned 3

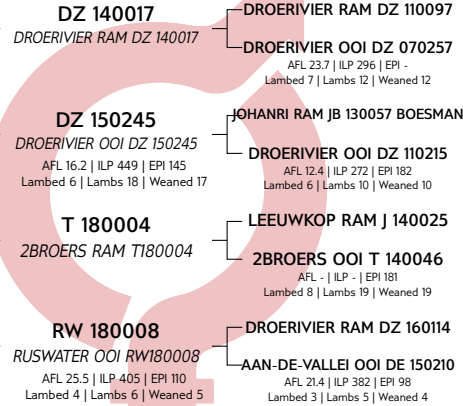

Growth			Reproduction			
Wn. Dir.	Wean Mat.	Post-Wn.	NLW	TWW	AFL	ILP
89	108	88	96	96	105	105
62%	54%	59%	45%	45%	42%	36%



EBV Analysis 2024-02-02

Logix Merit Index	97
Growth Index	96
Reproduction Index	105

SELLER REMARKS: KOMMERSIEEL

LOT 50 (M)



RW 220195
RUSWATER RAM RW 220195

Herd Book	SP
Birth date	2022-10-09
Age	1.4 years
Inbreeding	5.41%
Birth Stat.	1
Progeny	None

F.J. KRUGER
Potchefstroom, North West
0828591867
ruswater.kruger@gmail.com

DZ 170043
DROERIVIER RAM DZ 170043

Parentage Sire Dam
DNA
Genomic

RW 210083
RUSWATER OOI RW 210083
AFL 16.7 | ILP 283 | EPI 127
Lambd 2 | Lams 3 | Weaned 3

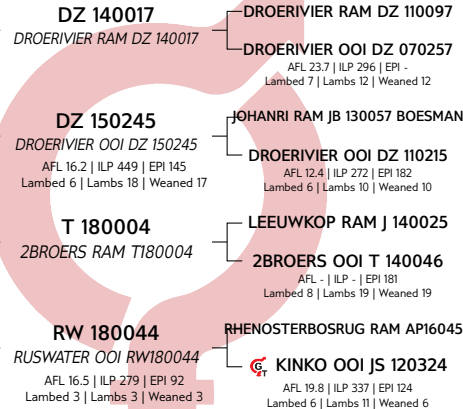

Growth			Reproduction			
Wn. Dir.	Wean Mat.	Post-Wn.	NLW	TWW	AFL	ILP
90	106	90	84	84	107	108
61%	53%	59%	44%	44%	42%	36%



EBV Analysis 2024-02-02

Logix Merit Index	91
Growth Index	97
Reproduction Index	94

SELLER REMARKS: KOMMERSIEEL

LOT 51 (M)



RW 220143
RUSWATER RAM RW 220143

Herd Book	SP
Birth date	2022-10-04
Age	1.4 years
Inbreeding	4.64%
Birth Stat.	1
Progeny	None

F.J. KRUGER
Potchefstroom, North West
0828591867
ruswater.kruger@gmail.com

NB 190462
NOVA BARLETTA RAM NB190462

Parentage Sire Dam
DNA
Genomic

RW 210123
RUSWATER OOI RW 210123
AFL 16 | ILP - | EPI 98
Lambd 1 | Lams 1 | Weaned 1

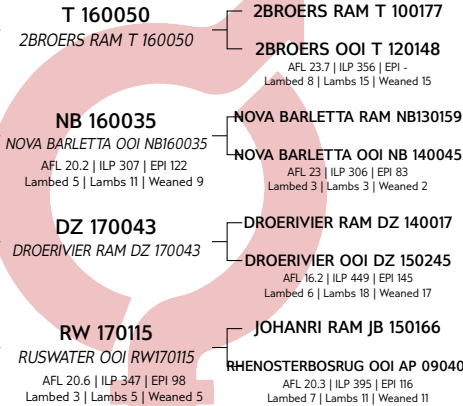

Growth			Reproduction			
Wn. Dir.	Wean Mat.	Post-Wn.	NLW	TWW	AFL	ILP
93	99	90	98	98	118	105
61%	52%	56%	41%	41%	41%	30%



EBV Analysis 2024-02-02

Logix Merit Index	100
Growth Index	95
Reproduction Index	106

SELLER REMARKS: KOMMERSIEEL

LOT 52 (M)



RW 220213
RUSWATER RAM RW 220213

Kuddeboek	
Geb. dtm 2022-10-20	
Oud. 1.3 jaar	
Inteling 6.21%	
Geb. Status 2	
Nageslag	
Geen	

F.J. KRUGER
Potchefstroom, North West
0828591867
ruswater.kruger@gmail.com

Ouerskap Vaar Moer

DNS
Genomies

RW 190100
RUSWATER EWE RW 190100
OEL - | ILP 524 | OPI 100
Gelam 2 | Lammers 4 | Gespeen 3

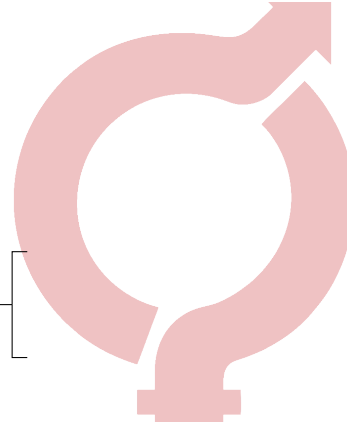

Groeï			Reproduksie			
Spn. Dir.	Spn. Mat.	Na-Spn.	GLS	TWW	OEL	ILP
70	98	74	76	76	92	115
35%	24%	34%	5%	5%	5%	5%



EBV Analise 2024-02-02

Logix Meriete Indeks	64
Groeï Indeks	73
Reproduksie Indeks	72

VERKOPER OPMERKINGS: KOMMERSIEEL

EXPLANATION OF CATALOGUE ABBREVIATIONS		VERDUIDELIKING VAN KATALOGUS AFKORTINGS	
Lot Number	LOT	LOT	Lot Nommer
Animal sex: M - Male, F - Female	M / F	M / V	Dier geslag: M - Manlik, V - Vroulik
Estimated breeding value	EBV	EBV	Beraamde teelwaarde
Animal identification number	ID	ID	Dier se identifikasie nommer
Herd Book Section (SEC)	Herd Book	Kuddeboek	Kuddeboek Afdeling (SEC)
SEC: Pending Registration	PEN	PEN	SEC: Wag vir Registrasie
SEC: Not for Registration	NFR	NFR	SEC: Nie vir Registrasie
SEC: Foundation Generation	FO	FO	SEC: Fondasie Generasie
SEC: Appendix A	A	A	SEC: Aanhangsel A
SEC: Appendix B	B	B	SEC: Aanhangsel B
SEC: Studbook Proper, a registered animal	SP	SP	SEC: Studbook Proper, 'n geregistreerde dier
Age in years	AGE	OUD.	Ouderdom in jaar
Animal is a singleton, Twin, Triplet etc.	Birth Stat.	Geb. Status	Dier is n enkeling, tweeling, drieling esv.
Age at First Lambing	AFL	OEL	Ouderdom met Eerst Lamming
Inter-Lambing Period	ILP	ILP	Interlam Periode
Ewe Production Index	EPI	OPI	Ooi Produksie Indeks
Number of times lambed	Lambed	Gelam	Aantal keer gelam
Number of lambs born	Lambs	Lammers	Aantal lammers gebore
Number of lambs weaned	Weaned	Gespeen	Aantal lammers gespeen
Parentage verification	Parentage	Ouerskap	Ouerskap verifikasie
Microsatellite parentage verification	DNA	DNS	Mikrosateliet ouerskap verifikasie
Microsatellite parentage verification	DNA	DNS	Mikrosateliet ouerskap verifikasie
Genomic Testing via SNPs	Genomic	Genomies	Genetiese toetsing dmv SNPs
Genomically Tested	GT	GT	Genomies Getoets
Logix Merit Index	LMI	LMI	Logix Meriete Indeks
Growth Index	GI	GI	Groei Indeks
Reproduction Index	RI	RI	Reproduksie Indeks
Wean Direct breeding value	Wean Dir.	Spn. Dir.	Speen Direk teelwaarde
Wean Maternal breeding value	Wean Mat.	SPn. Mat.	Speen Maternaal teelwaarde
Post-Wean breeding value	Post-Wn.	Na-pn.	Na-Speen teelwaarde
Number of Lambs Weaned breeding value	NLW	GLS	Getal Lammers Gespeen teelwaarde
Total Weight Weaned breeding value	TWW	TWW	Totale Gewig Gespeen teelwaarde



NW Dormers

Potchefstroom 17 February 2024



<u>Kommersiele Ooie</u>				
Lot	Diere	Pakkie	Opmerkings	Status
LOT 53	FISANTVLEI DORMERS	5	2 Tand Ooie	
LOT 54	FISANTVLEI DORMERS	5	2 Tand Ooie	
LOT 55	Hoogland Boerdery Pty Ltd	5	Wissel/2 Tand Ooie	Dragtig
LOT 56	Hoogland Boerdery Pty Ltd	5	Wissel Ooie	Dragtig
LOT 57	Wynboom Boerdery	5	2 Tand Ooie	Oop
LOT 58	Wynboom Boerdery	5	Jong Ooie	Oop
LOT 59	Wynboom Boerdery	5	Jong Ooie	Oop
LOT 60	Blinkster Boerdery	5	Wissel Ooie	Dragtig
LOT 61	Blinkster Boerdery	5	Wissel Ooie	Dragtig
LOT 62	FISANTVLEI DORMERS	5	2 Tand Ooie	
LOT 63	FISANTVLEI DORMERS	5	2 Tand Ooie	
LOT 64	Hoogland Boerdery Pty Ltd	5	Wissel	By Ram Geloop



NW Dormers

Potchefstroom 17 February 2024



<u>Kommersiele Ooie</u>				
Lot	Diere	Pakkie	Opmerkings	Status
LOT 65	Hoogland Boerdery Pty Ltd	5	Wissel	By Ram Geloop
LOT 66	Wynboom Boerdery	5	Jong Ooie	Oop
LOT 67	Wynboom Boerdery	5	Jong Ooie	Oop
LOT 68	Wynboom Boerdery	5	Jong Ooie	Oop
LOT 69	Blinkster Boerdery	5	Wissel Ooie	Dragtig
LOT 70	Blinkster Boerdery	5	Wissel Ooie	Oop
LOT 71	FISANTVLEI DORMERS	5	2 Tand Ooie	
LOT 72	FISANTVLEI DORMERS	5	2 Tand Ooie	
LOT 73	Wynboom Boerdery	5	Jong Ooie	Oop
LOT 74	Wynboom Boerdery	5	Jong Ooie	Oop
LOT 75	Wynboom Boerdery	5	Jong Ooie	Oop
LOT 76	Wynboom Boerdery	5	6 maande	Oop